

## Hinnakiri 2013

TECEflex  
TECElogo  
TECEfloor

**TECE:**

Intelligente Haustechnik

## Austria

### TECE GmbH

Igelschwang 10  
A - 3313 Wallsee  
Phone: +43-160 463 060  
Fax: +43-160 463 064  
info@tece.at  
www.tece.at

## Prantsusmaa

### TECE France S.A.R.L.

5, rue Jean Rostand  
F - 69740 Genas  
Phone: +33-437 453 810  
Fax: +33-437 454 110  
info@tece.fr  
www.tece.fr

## Poola

### TECE Sp. z o.o.

Wroclawska 61  
PL - 57-100 Strzelin  
Phone: +48-713 839 100  
Fax: +48-713 839 101  
tece@tece.pl  
www.tece.pl

## Eesti

### TECE Baltikum UAB

Eesti Filiaal  
Mere pst. 8, 101 1 1 Tallinn  
Phone: +372 6 781 100  
Fax: +372 6 7801 1 1  
info@tece.ee  
www.tece.ee

## Saksamaa

### TECE GmbH

Hollefeldstraße 57  
D - 48282 Emsdetten  
Phone: +49 2572 928 0  
Fax: +49 2572 928 124  
info@tece.de  
www.tece.de

## Rumeenia

### TECE Romania SRL

Soseaua de Centura, nr. 43-45  
RO - 077040 Chiajna, Ilfov  
Phone: +40-21 203 47 08  
Fax: +40-31 030 47 10  
info@tece.ro  
www.tece.ro

## Belgia

### TECE BELGIUM BVBA-SPRL

Korte Kievistraat 22/C12  
B - 2018 Antwerpen  
Phone: +32-2 401 61 37  
Fax: +32-2 401 61 38  
info@tece.be  
www.tece.be

## Itaalia

### TECE Italia srl.

Via dell'Industria, 24/A  
I - 41051 Castelnuovo Rangone (MO)  
Phone: +39-0 595 334 011  
Fax: +39-0 595 334 010  
info@teceitalia.com  
www.teceitalia.com

## Venemaa

### 000 TECE Systems

Golyevo, ul. Centralnaya 3,  
RUS - 143403 Krasnogorski District,  
Moscow Region  
Phone: +7-495-988 07 94  
Fax: +7-495-988 07 95  
info@tece.ru  
www.tece.ru

## Läti

### TECE Baltikum UAB

Filiāle Latvijas Republikā  
Mūkusalas iela 41B-8  
Rīga, LV-1004, Latvija  
Phone: +371 67 21 18 02  
Fax: +371 67 21 18 05  
www.tece.lv/info@tece.lv

## Leedu

### TECE Baltikum UAB

Terminalo g. 10  
Biruliškių k., Kauno raj.,  
LT-54469  
Phone: +37-037 314 078  
Fax: +37-037 313 085  
info@tece.lt  
www.tece.lt

## Hispaania

### TECE Haustechnik, S.L.

Enrique Mariñas, 36-5° Oficina 2  
Edificio Torre de Cristal  
E - 15009 A Coruña  
Phone: +34-881 89 50 25  
Fax: +34-881 89 50 26  
info@tece.es  
www.tece.es

## Horvaatia

### TECE Trgovina d.o.o

Fallerovo setaliste 16  
HR - 10000 Zagreb  
Phone: +38-513 079 000  
Fax: +38-513 079 048  
prodaja@tece.hr  
www.tece.hr

## Holland

### TECE Nederland GmbH

W.A. Scholtenweg 7 a  
NL - 9422 BR Smilde  
Phone: +31-592 415 074  
Fax: +31-592 414 628  
info@tece-nederland.nl  
www.tece-nederland.nl

## Šveits

### TECE Schweiz AG

Gewerbestrasse 8  
CH - 8212 Neuhausen am Rheinfall  
Phone: +41-52 672 62 20  
Fax: +41-52 672 62 21  
info@tece.ch  
www.tece.ch

## Tšehhi Vabariik

### TECE Česká republika, s.r.o.

Prosecká 852/66  
CZ - 190 00 Praha 9 - Prosek  
Phone: +420 266 107 226  
Fax: +420 266 107 228  
info@tece.cz  
www.tece.cz

## Norra

### PROBATA AS

Tømteveien 12  
N - 1410 Kolbotn  
Phone: +47-66 82 33 00  
Fax: +47-66 82 33 00  
post@probata.no  
www.tece.no

## Ukraina

### TOV TECE Ukraine

18 Malins'ka Str.  
UA - 03680 Kyiv  
Phone: +38-044 450 17 24  
Fax: +38-044 450 17 24  
info@tece.ua  
www.tece.ua



**TECEflex** \_\_\_\_\_ 5



**TECElogo** \_\_\_\_\_ 39



**TECEfloor** \_\_\_\_\_ 57





**TECEflex**  
**Hinnakiri 2013**

## TECEflex mitmekihiline toru

### Kasutamine joogivee-, kütte- ja suruõhusüsteemides.

TECEflex mitmekihiline toru ühendab endas ideaalselt metall- ja plasttoru omadused. Toru vastab joogivee-, kütte- ja suruõhu paigaldamise nõuetele. TECEflex mitmekihilist toru saab kergesti käsitsi painutada, kuid samas säilitab ta oma kuju ja jäikuse. Kõrge stabiilsus ja tugevus on saavutatud sisemise polüetüleenist PE-Xc kandetoruga, mis on kokku sulatatud elektronkiire meetodil.

## TECEflex mitmekihilise toru eelised

- Lihtne käsitsi painutada
- Kõrge turvalisuse reserv tänu toru erilisele koostisele
- Toru paindub hästi, kuid säilitab oma jäikuse
- Joonpaisumine on analoogne metalltorudega
- Pärast löikamist jääb toru pind sile ja ümmargune
- 100 % hapnikutihedus
- 100 % lõhnatihe

## Täiuslik kombinatsioon ...

### TECEflex liitmikud ja TECEflex mitmekihiline toru

TECEflex liitmikud ei ole kummitihendeid. Ühenduste lekkekindlus saavutatakse tänu PE-Xc toru mälu efektile. TECEflex ühendamise tehnika võimaldab torude ühenduskohtade ristlõiget mitte vähendada, mis mõjub hästi süsteemi hüdraulikale.

- Samad liitmikud nii mitmekihilisel torul kui PE-Xc torul
- Kõrge töökindlus
- Minimaalne vahe toru ja liitmiku sisediameetrial
- TECEflex liitmikud on valmistatud korrosioonikindlast messingust või kvaliteetsest PPSU plastikust

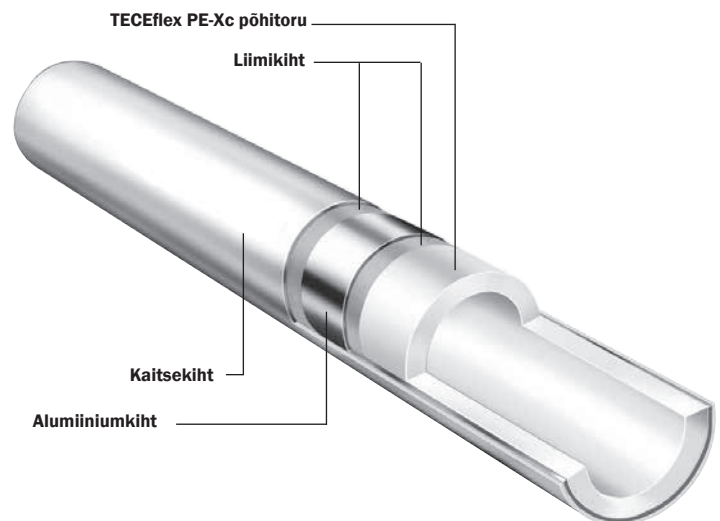

## Lihtne paigaldus kasutades TECEflex sururõnga süsteemi

Laiendage toru, lükake liitmik sisse, suruge liitmik ja sururõngas kokku ja ühendus on valmis!

Ei ole tarvis toru kraatida, servi töödelda ega märgistada liitmiku sügavust. Ühendused, mis pole veel kokku pressitud on lihtsalt äratuntavad, kuna sururõngas on toru peal lahtiselt – see on aksiaalse toruühenduse üks eeliseid.

Lisaks tunneb pressimata ühendusi ära selle järgi, et ühenduse vahelt tuleb vesi läbi.

- Lühikesed paigaldusajad, tänu lihtsale tehnoloogiale
- Puudub vajadus pakkimiseks, kraatimiseks, jootmiseks või keevitamiseks
- Metallist liitmikud, mida on juba kasutatud, saab uuesti lahti kuumutada ja uuesti kasutada. (Sururõngaid ei soovita uuesti taaskasutada)
- Lihtne ühendusi teostada RazFaz akutööriistaga kuni 32mm
- Suurematel diameetritel kasutatakse elektritööriistu



kiwa

DIN CERTCO

KOMO



	Lehekülg
TECEflex mitmekihiline toru	8
TECEflex universaalne mitmekihiline toru PE-Xc 5S	9
TECEflex sururõngad	10
TECEflex liitmikud	11
TECEflex liitmikud ja kaitsekarbid	17
TECEflex seinakannad	18
TECEflex kinnituskomplektid ja jaotuskollektorid	20
TECEflex adapterid	22
TECEflex radiaatorite ühendustarvikud	25
TECEflex tööriistad	29
TECEflex varuosad	36
Projekteerimistarkvara	38

# TECEflex – mitmekihiline toru



TECEflex mitmekihiline toru

## TECEflex mitmekihiline toru PE-Xc/Al/PE

TECEflex mitmekihilised torud valmistatakse PE-Xc baastorust, kus baastoru on kaetud 100% hapnikukindlast alumiiniumist kaitsekihiga, mis omakorda on kaetud PE materjalist valge kaitsekihiga. Alumiiniumkest toimib hapnikutõkkena ja vähendab ühtlasi kõikidele polüetüleentorudele iseäralikku lineaarset paisumist. Universaalsel PE-Xc/Al/PE torul on metalli- ja polüetüleentorude parimad omadused - vähene lineaarne paisumine, paindlikkus, korrosioonikindlus, vastupidavus suurtele temperatuurikõikumistele ja rõhukoormusele. Tänu valgele värvile saab toru paigaldada nähtavale kohale. Kasutatakse veevärgi-, küttesüsteemi- ja pörandakütte paigaldistes, ning magistraalitorustike ja pörandaaluste süsteemide paigaldamisel.

TECEflex mitmekihilist toru painutatakse käsitsi – selleks ei ole vaja kasutada painutusvahendeid nagu teiste mitmekihiliste torude puhul.

Patenteeritud, kummitihendeid mittevajavate pealetõmmatavate rõngastega TECEflex toruühendus võimaldab ühenduskohas alles hoida puhta läbilõike. TECEflex mitmekihiliste torude puhul kasutatakse samu liitmikke kui TECEflex küttesüsteemi- ja veevärgitorude puhul.

## TECEflex mitmekihiline toru sobib joogiveele, pörandakütte ja küttesüsteemidesse.

Laserkeevitatud alumiiniumkiht on hapnikukindel, välimine kaitsev PE kiht on valge.

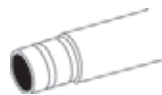

Diameeter	Tootekood	Kogus (pak. 1)	Kogus (pak. 2)	Kogus (pak. 3)	EUR/ jm ilma KM
∅ 16 mm rull	7 320 16	100 m	1000 m	2000 m	1,52
∅ 20 mm rull	7 320 20	100 m	700 m	1400 m	2,13
∅ 25 mm rull	7 320 25	50 m	250 m	500 m	4,03
∅ 32 mm rull	7 320 32	25 m	--	--	7,09
∅ 16 mm latt	7 322 16	100 m	--	--	1,62
∅ 20 mm latt	7 322 20	70 m	--	--	2,12
∅ 25 mm latt	7 322 25	45 m	--	--	4,26
∅ 32 mm latt	7 322 32	30 m	--	--	7,33
∅ 40 mm latt	7 322 40	15 m	--	--	13,47
∅ 50 mm latt	7 322 50	15 m	--	--	24,85
∅ 63 mm latt	7 322 63	5 m	--	--	41,13

Latis toru pikkus 5 m





## TECEflex universaalne mitmekihiline PE-Xc 5S toru

TECEflex universaalne mitmekihiline PE-Xc 5S toru vee- ja küttesüsteemidele. TECEflex mitmekihilised torud valmistatakse PE-Xc baastorust, mis on kaetud unikaalse EVOH alumiiniumkihiga, mis toimib hapnikutõkkena DIN4726 standardi järgi. Alumiiniumkiht vähendab ka polüetüleenitorudele iseäralikku lineaarset paisumist. Välimine PE-Xc kiht kaitseb toru ultraviolettkiirte ja mehaaniliste vigastuste eest.

Toode vastab kõikidele sanitaarsetele ja hügieenilistele nõuetele ja omab ka vastavaid sertifikaate. Toru on väga elastne, seda on lihtne ja kiire painutada ja paigaldada.

Patenteeritud, kummitihendeid mittevajavate pealetõmmatavate rõngastega TECEflex toruühendus võimaldab ühenduskohas alles hoida puhta läbilõike. TECEflex universaalsete PE-Xc 5S mitmekihiliste torude puhul kasutatakse samu liitmikke kui TECEflex küttesüsteemi- ja veevärgitorude puhul.

## TECEflex PE-Xc 5S mitmekihiline toru

### TECEflex universaalne mitmekihiline PE-Xc 5S toru vee- ja küttesüsteemidele

Joogivee sertifikaat DIN EN ISO 15875,  
Alumiinium difusioonikiht vastavalt DIN 4726.



Diameeter	Tootekood	Kogus (pak. 1)	Kogus (pak. 2)	Kogus (pak. 3)	EUR/ jm ilma KM
ø 16 mm	7 045 16	200 m	1200 m	2400 m	1,42
ø 20 mm	7 045 20	120 m	840 m	1680 m	2,16

# TECEflex – sururõngad

## Sururõngad mitmekihilistele PE-Xc/Al/PE torudele (messing)

### Tähelepanu:

Ära unusta liitmikutele lisaks tellida sururõngaid.

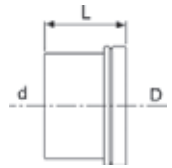

Diameeter	Tootekood	Kogus (pak. 1)	Kogus (pak. 2)	EUR/tk ilma KM	L	D	d
ø 16 mm	7 345 16	50 tk.	500 tk.	0,81	15,0 mm	22,5 mm	21,7 mm
ø 20 mm	7 345 20	50 tk.	500 tk.	0,93	17,5 mm	27,0 mm	26,2 mm
ø 25 mm	7 345 25	50 tk.	250 tk.	1,83	24,5 mm	33,0 mm	32,0 mm
ø 32 mm	7 345 32	25 tk.	100 tk.	2,86	32,0 mm	40,0 mm	38,5 mm
ø 40 mm	7 345 40	15 tk.	60 tk.	4,79	35,0 mm	48,0 mm	47,0 mm
ø 50 mm	7 345 50	10 tk.	50 tk.	7,09	40,0 mm	58,0 mm	57,0 mm
ø 63 mm	7 345 63	5 tk.	20 tk.	11,64	47,0 mm	73,0 mm	65,0 mm

## Sururõngad PE-Xc 5S ja PE-MDXc torudele (nikeldatud)

### Tähelepanu:

Ära unusta liitmikutele lisaks tellida sururõngaid.

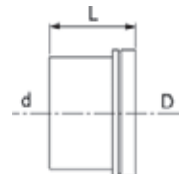

Diameeter	Tootekood	Kogus (pak. 1)	Kogus (pak. 2)	EUR/tk ilma KM	L	D	d
ø 16 mm	7 040 16	50 tk.	500 tk.	0,72	15,0 mm	22,0 mm	21,6 mm
ø 20 mm	7 040 20	50 tk.	500 tk.	0,86	17,5 mm	26,0 mm	25,0 mm

**Messingist üleminekumuhv SK**

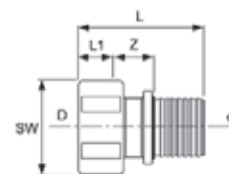
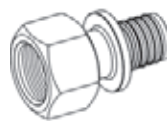

Diameeter	Tootekood	Kogus (pak. 1)	Kogus (pak. 2)	EUR/tk ilma KM	Z	L	L1	D	d	SW
∅ 16 mm x 1/2" SK	7 050 02	10 tk.	100 tk.	3,84	18,0 mm	44,8 mm	11,0 mm	1/2" SK	16,0	27
∅ 20 mm x 1/2" SK	7 050 03	10 tk.	100 tk.	4,17	18,0 mm	47,0 mm	11,0 mm	1/2" SK	20,0	27
∅ 20 mm x 3/4" SK	7 050 04	10 tk.	100 tk.	4,43	20,0 mm	49,5 mm	12,0 mm	3/4" SK	20,0	27
∅ 25 mm x 3/4" SK	7 050 07	10 tk.	100 tk.	5,91	20,0 mm	57,0 mm	12,0 mm	3/4" SK	25,0	34
∅ 25 mm x 1" SK	7 050 09	5 tk.	20 tk.	8,57	24,0 mm	62,0 mm	14,0 mm	1" SK	25,0	40
∅ 32 mm x 1" SK	7 050 08	5 tk.	20 tk.	9,45	24,0 mm	69,5 mm	14,0 mm	1" SK	32,0	40
∅ 40 mm x 1 1/2" SK	7 050 10	2 tk.	20 tk.	17,22	28,0 mm	77,5 mm	14,0 mm	1 1/2" SK	40,0	56
∅ 50 mm x 2" SK	7 050 11	2 tk.	10 tk.	28,33	30,0 mm	90,5 mm	23,0 mm	2" SK	50,0	69
∅ 63 mm x 2" SK	7 050 14	1 tk.	5 tk.	63,43	38,0 mm	113,0 mm	28,0 mm	2" SK	63,0	85

**Messingist üleminekunippel VK**

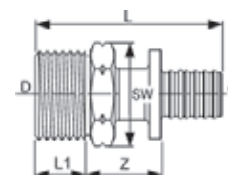

Diameeter	Tootekood	Kogus (pak. 1)	Kogus (pak. 2)	EUR/tk ilma KM	Z	L	L1	D	d	SW
∅ 16 mm x 1/2" VK	7 055 02	10 tk.	100 tk.	3,84	18,0 mm	47,8 mm	13,2 mm	1/2" VK	16	22
∅ 16 mm x 3/4" VK	7 055 06	10 tk.	100 tk.	4,20	18,0 mm	49,1 mm	14,5 mm	3/4" VK	16	27
∅ 20 mm x 1/2" VK	7 055 03	10 tk.	100 tk.	4,20	19,0 mm	50,0 mm	13,2 mm	1/2" VK	20	27
∅ 20 mm x 3/4" VK	7 055 04	10 tk.	100 tk.	4,28	19,0 mm	51,3 mm	14,5 mm	3/4" VK	20	27
∅ 25 mm x 3/4" VK	7 055 07	10 tk.	50 tk.	5,38	23,0 mm	61,3 mm	14,5 mm	3/4" VK	25	34
∅ 25 mm x 1" VK	7 055 08	10 tk.	50 tk.	6,91	25,0 mm	66,1 mm	16,8 mm	1" VK	25	34
∅ 32 mm x 1" VK	7 055 09	5 tk.	50 tk.	9,45	25,0 mm	74,6 mm	16,8 mm	1" VK	32	34
∅ 32 mm x 1 1/4" VK	7 055 10	5 tk.	50 tk.	12,70	26,0 mm	76,9 mm	19,1 mm	1 1/4" VK	32	43
∅ 40 mm x 1 1/4" VK	7 055 11	2 tk.	20 tk.	13,29	28,0 mm	81,0 mm	19,1 mm	1 1/4" VK	40	43
∅ 50 mm x 1 1/2" VK	7 055 12	2 tk.	10 tk.	21,27	28,0 mm	87,5 mm	19,1 mm	1 1/2" VK	50	48
∅ 63 mm x 2" VK	7 055 13	1 tk.	5 tk.	32,63	30,0 mm	100,0 mm	23,4 mm	2" VK	63	60

# TECEflex – liitmikud

## Plastist jätkuliitmik PPSU

**P**

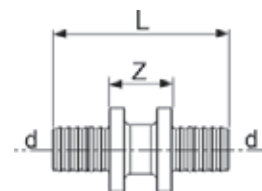

Diameeter	Tootekood	Kogus (pak. 1)	Kogus (pak. 2)	EUR/tk ilma KM	Z	L	d
∅ 16 mm/16 mm	7 360 16	10 tk.	100 tk.	2,42	16,5 mm	47,1 mm	16 mm
∅ 20 mm/20 mm	7 360 20	10 tk.	100 tk.	2,69	18,0 mm	53,5 mm	20 mm

## Messingist jätkuliitmik

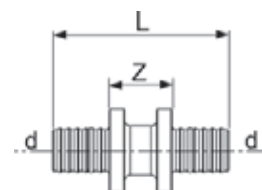

Diameeter	Tootekood	Kogus (pak. 1)	Kogus (pak. 2)	EUR/tk ilma KM	Z	L	d
∅ 16 mm/16 mm	7 060 16	10 tk.	100 tk.	2,99	15,0 mm	45,1 mm	16 mm
∅ 20 mm/20 mm	7 060 20	10 tk.	100 tk.	3,54	15,0 mm	49,5 mm	20 mm
∅ 25 mm/25 mm	7 060 25	10 tk.	50 tk.	4,11	17,0 mm	65,5 mm	25 mm
∅ 32 mm/32 mm	7 060 32	5 tk.	50 tk.	8,80	18,0 mm	82,5 mm	32 mm
∅ 40 mm/40 mm	7 060 40	2 tk.	20 tk.	14,18	19,0 mm	90,5 mm	40 mm
∅ 50 mm/50 mm	7 060 50	2 tk.	10 tk.	23,04	21,0 mm	102,5 mm	50 mm
∅ 63 mm/63 mm	7 060 63	1 tk.	5 tk.	33,67	27,0 mm	118,0 mm	63 mm

## Plastist üleminek PPSU

**P**

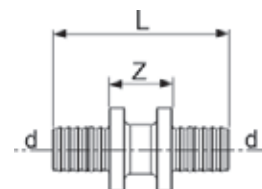

Diameeter	Tootekood	Kogus (pak. 1)	Kogus (pak. 2)	EUR/tk ilma KM	Z	L	d	d1
∅ 20 mm/16 mm	7 365 03	10 tk.	50 tk.	2,42	18,0 mm	50,0 mm	20 mm	16 mm

## Messingist üleminek

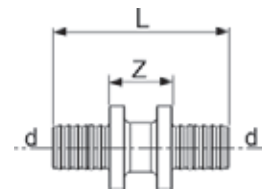

Diameeter	Tootekood	Kogus (pak. 1)	Kogus (pak. 2)	EUR/tk ilma KM	Z	L	d	d1
∅ 20 mm/16 mm	7 065 03	10 tk.	100 tk.	3,60	15,0 mm	47,3 mm	20 mm	16 mm
∅ 25 mm/16 mm	7 065 04	10 tk.	50 tk.	4,60	16,0 mm	55,3 mm	25 mm	16 mm
∅ 25 mm/20 mm	7 065 05	10 tk.	50 tk.	3,88	15,0 mm	57,0 mm	25 mm	20 mm
∅ 32 mm/20 mm	7 065 06	5 tk.	30 tk.	8,40	17,0 mm	66,0 mm	32 mm	20 mm
∅ 32 mm/25 mm	7 065 07	5 tk.	30 tk.	8,74	18,0 mm	74,0 mm	32 mm	25 mm
∅ 40 mm/32 mm	7 065 08	2 tk.	20 tk.	15,07	20,0 mm	86,5 mm	40 mm	32 mm
∅ 50 mm/40 mm	7 065 09	2 tk.	10 tk.	22,84	22,0 mm	96,5 mm	50 mm	40 mm
∅ 63 mm/50 mm	7 065 10	1 tk.	5 tk.	32,35	27,0 mm	111,0 mm	63 mm	50 mm

**Põlv 90° PPSU**

**P**

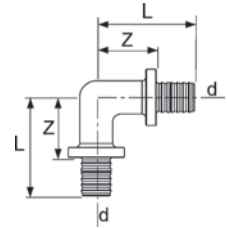
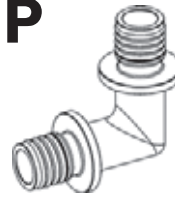

Diameeter	Tootekood	Kogus (pak. 1)	Kogus (pak. 2)	EUR/tk ilma KM	Z	L	d
∅ 16 mm/16 mm	7 370 16	10 tk.	100 tk.	2,63	24,0 mm	38,8 mm	16 mm
∅ 20 mm/20 mm	7 370 20	10 tk.	100 tk.	2,90	26,0 mm	43,5 mm	20 mm

**Messingist põlv 90°**

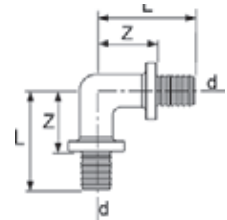
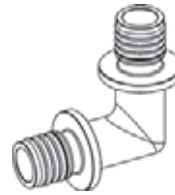

Diameeter	Tootekood	Kogus (pak. 1)	Kogus (pak. 2)	EUR/tk ilma KM	Z	L	d
∅ 16 mm/16 mm	7 070 16	10 tk.	200 tk.	3,88	23,0 mm	37,8 mm	16 mm
∅ 20 mm/20 mm	7 070 20	10 tk.	100 tk.	4,22	25,0 mm	42,0 mm	20 mm
∅ 25 mm/25 mm	7 070 25	10 tk..	40 tk.	7,62	30,0 mm	53,5 mm	25 mm
∅ 32 mm/32 mm	7 070 32	5 tk.	40 tk.	14,45	34,0 mm	65,5 mm	32 mm
∅ 40 mm/40 mm	7 070 40	2 tk.	20 tk.	20,09	39,0 mm	72,5 mm	40 mm
∅ 50 mm/50 mm	7 070 50	2 tk.	10 tk.	32,50	44,0 mm	83,5 mm	50 mm
∅ 63 mm/63 mm	7 070 63	1 tk.	5 tk.	49,26	53,0 mm	98,5 mm	63 mm

**Messingist lauge põlv 90° , vähendab rõhukadu**

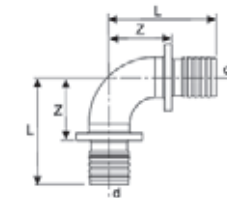
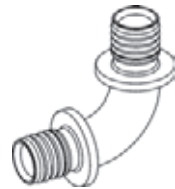

Diameeter	Tootekood	Kogus (pak. 1)	Kogus (pak. 2)	EUR/tk ilma KM	Z	L	d
∅ 16 mm/16 mm	7 072 16	10 tk.	200 tk.	7,20	24,5 mm	43,0 mm	16 mm
∅ 20 mm/20 mm	7 072 20	10 tk.	100 tk.	8,74	28,0 mm	47,0 mm	20 mm
∅ 25 mm/25 mm	7 072 25	10 tk..	40 tk.	13,37	32,0 mm	58,5 mm	25 mm
∅ 32 mm/32 mm	7 072 32	5 tk.	40 tk.	18,24	33,5 mm	70,5 mm	32 mm
∅ 40 mm/40 mm	7 072 40	2 tk.	20 tk.	33,61	41,0 mm	82,0 mm	40 mm
∅ 50 mm/50 mm	7 072 50	2 tk.	10 tk.	42,13	46,0 mm	93,0 mm	50 mm
∅ 63 mm/63 mm	7 072 63	1 tk.	5 tk.	77,05	52,5 mm	106,5 mm	63 mm

**Messingist põlv 45°**

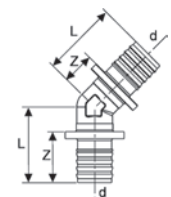

Diameeter	Tootekood	Kogus (pak. 1)	Kogus (pak. 2)	EUR/tk ilma KM	Z	L	d
∅ 25 mm/25 mm	7 071 25	10 tk..	40 tk.	12,42	15,7 mm	40,2 mm	25 mm
∅ 32 mm/32 mm	7 071 32	5 tk.	20 tk.	20,27	18,2 mm	50,2 mm	32 mm
∅ 40 mm/40 mm	7 071 40	2 tk.	20 tk.	25,41	22,0 mm	55,5 mm	40 mm
∅ 50 mm/50 mm	7 071 50	2 tk.	10 tk.	38,40	24,0 mm	63,6 mm	50 mm
∅ 63 mm/63 mm	7 071 63	1 tk.	5 tk.	71,79	28,5 mm	74,0 mm	63 mm

# TECEflex – liitmikud

## Messingist kork

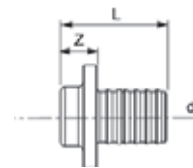

Diameeter	Tootekood	Kogus (pak. 1)	Kogus (pak. 2)	EUR/tk ilma KM	Z	L	d
∅ 16 mm	7 205 16	10 tk.	200 tk.	2,30	8,0 mm	23,3 mm	16 mm
∅ 20 mm	7 205 20	10 tk.	200 tk.	2,36	8,0 mm	25,5 mm	20 mm

## Messingist põlv sisekeermega

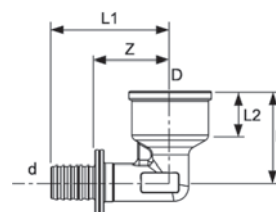
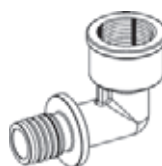

Diameeter	Tootekood	Kogus (pak. 1)	Kogus (pak. 2)	EUR/tk ilma KM	Z	L	L1	L2	D	d
∅ 16 mm x 1/2" SK	7 080 16	10 tk.	150 tk.	3,97	26,0 mm	31,0 mm	40,8 mm	11,0	1/2" SK	16
∅ 20 mm x 1/2" SK	7 080 20	10 tk.	150 tk.	4,43	26,0 mm	33,0 mm	43,0 mm	11,0	1/2" SK	20
∅ 20 mm x 3/4" SK	7 080 02	10 tk.	50 tk.	6,20	29,0 mm	39,5 mm	46,0 mm	14,5	3/4" SK	20
∅ 25 mm x 3/4" SK	7 080 25	10 tk.	40 tk.	7,09	30,0 mm	39,5 mm	54,0 mm	12,0	3/4" SK	25
∅ 32 mm x 1" SK	7 080 32	5 tk.	20 tk.	14,45	35,0 mm	44,5 mm	66,5 mm	14,0	1" SK	32
∅ 40 mm x 1 1/2" SK	7 080 40	2 tk.	10 tk.	26,65	42,0 mm	50,2 mm	75,5 mm	21,4	1 1/2" SK	40
∅ 50 mm x 1 1/2" SK	7 080 50	2 tk.	10 tk.	36,63	43,0 mm	52,2 mm	81,5 mm	21,4	1 1/2" SK	50

## Messingist põlv väliskeermega

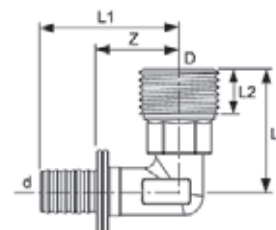
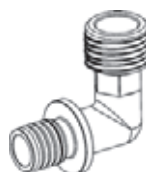

Diameeter	Tootekood	Kogus (pak. 1)	Kogus (pak. 2)	EUR/tk ilma KM.	Z	L	L1	L2	D	d
∅ 16 mm x 1/2" VK	7 075 16	10 tk.	80 tk.	3,99	22,0 mm	37,0 mm	37,3 mm	13,0	1/2" VK	16
∅ 20 mm x 1/2" VK	7 075 20	10 tk.	80 tk.	5,91	22,0 mm	39,0 mm	39,5 mm	13,0	1/2" VK	20
∅ 20 mm x 3/4" VK	7 075 01	10 tk.	60 tk.	6,32	25,0 mm	40,3 mm	42,0 mm	14,5	3/4" VK	20
∅ 25 mm x 3/4" VK	7 075 25	10 tk.	50 tk.	6,75	26,0 mm	44,5 mm	50,5 mm	14,5	3/4" VK	25
∅ 25 mm x 1" VK	7 075 26	10 tk.	50 tk.	12,56	26,0 mm	60,0 mm	54,5 mm	19,1	1" VK	25
∅ 32 mm x 1" VK	7 075 32	10 tk.	20 tk.	13,29	26,0 mm	63,0 mm	56,0 mm	19,1	1" VK	32

**Messingist kolmik sisekeermega**

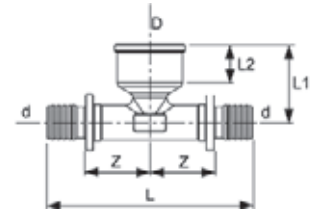
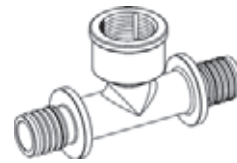

Diameeter	Toote- kood	Kogus (pak. 1)	Kogus (pak. 2)	EUR/tk ilma KM
∅ 16 mm x 1/2" SK x 16 mm	7 095 16	10 tk.	60 tk.	6,50
∅ 20 mm x 1/2" SK x 20 mm	7 095 20	10 tk.	40 tk.	7,39
∅ 25 mm x 1/2" SK x 25 mm	7 095 22	10 tk.	30 tk.	9,19
∅ 25 mm x 3/4" SK x 25 mm	7 095 25	10 tk.	20 tk.	11,28
∅ 32 mm x 1/2" SK x 32 mm	7 095 27	5 tk.	20 tk.	14,20
∅ 32 mm x 1" SK x 32 mm	7 095 32	5 tk.	20 tk.	17,37
∅ 40 mm x 1/2" SK x 40 mm	7 095 34	1 tk.	10 tk.	22,83
∅ 40 mm x 1" SK x 40 mm	7 095 40	1 tk.	10 tk.	26,88
∅ 50 mm x 1/2" SK x 50 mm	7 095 42	1 tk.	10 tk.	31,33
∅ 50 mm x 1 1/4" SK x 50 mm	7 095 50	1 tk.	10 tk.	34,86
∅ 63 mm x 1/2" SK x 63 mm	7 095 52	1 tk.	5 tk.	67,94
∅ 63 mm x 1" SK x 63 mm	7 095 63	1 tk.	5 tk.	76,10
∅ 63 mm x 1 1/2" SK x 63 mm	7 095 65	1 tk.	5 tk.	72,26

Z	L	L1	L2	D	d
26,0 mm	81,6 mm	31,0 mm	11,0 mm	1/2" SK	14 mm
26,0 mm	86,0 mm	33,0 mm	11,0 mm	1/2" SK	16 mm
23,0 mm	102,0 mm	25,0 mm	11,0 mm	1/2" SK	25 mm
30,0 mm	108,0 mm	39,5 mm	12,0 mm	3/4" SK	20 mm
23,0 mm	119,0 mm	22,0 mm	11,0 mm	1/2" SK	32 mm
29,0 mm	132,0 mm	45,0 mm	16,1 mm	1" SK	32 mm
28,5 mm	127,0 mm	26,0 mm	11,0 mm	1/2" SK	40 mm
35,0 mm	140,0 mm	47,5 mm	21,5 mm	1" SK	40 mm
29,5 mm	139,0 mm	30,0 mm	11,0 mm	1/2" SK	50 mm
41,5 mm	163,0 mm	54,5 mm	24,2 mm	1 1/4" SK	50 mm
51,5 mm	197,0 mm	43,0 mm	13,0 mm	1/2" SK	63 mm
51,5 mm	197,0 mm	60,5 mm	14,9 mm	1" SK	63 mm
51,5 mm	197,0 mm	41,0 mm	22,0 mm	1 1/2" SK	63 mm

**Plastist kolmik PPSU**

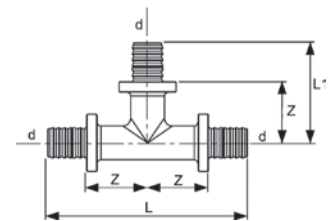
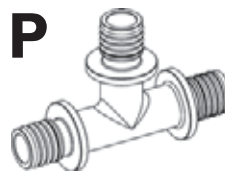

Diameeter	Toote- kood	Kogus (pak. 1)	Kogus (pak. 2)	EUR/tk ilma KM
∅ 16 x 16 x 16 mm	7 309 16	10 tk.	100 tk.	2,90
∅ 20 x 20 x 20 mm	7 309 20	10 tk.	80 tk.	3,60

Z	L	L1	d
24,0 mm	77,6 mm	38,5 mm	16 mm
26,0 mm	87,0 mm	43,5 mm	20 mm

**Messingist kolmik**

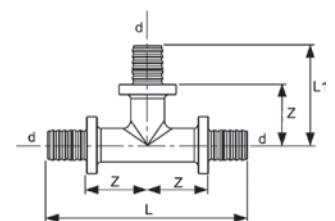
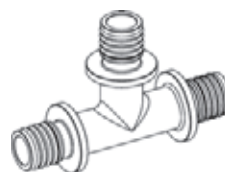

Diameeter	Toote- kood	Kogus (pak. 1)	Kogus (pak. 2)	EUR/tk ilma KM
∅ 16 x 16 x 16 mm	7 100 16	10 tk.	150 tk.	4,40
∅ 20 x 20 x 20 mm	7 100 20	10 tk.	80 tk.	5,02
∅ 25 x 25 x 25 mm	7 100 25	10 tk.	40 tk.	8,87
∅ 32 x 32 x 32 mm	7 100 32	5 tk.	20 tk.	14,68
∅ 40 x 40 x 40 mm	7 100 40	2 tk.	10 tk.	25,55
∅ 50 x 50 x 50 mm	7 100 50	1 tk.	5 tk.	51,40
∅ 63 x 63 x 63 mm	7 100 63	1 tk.	5 tk.	72,38

Z	L	L1	d
22,5 mm	75,6 mm	37,8 mm	16 mm
24,5 mm	84,0 mm	42,0 mm	20 mm
29,0 mm	107,0 mm	53,5 mm	25 mm
33,5 mm	131,0 mm	65,5 mm	32 mm
37,5 mm	145,0 mm	72,5 mm	40 mm
43,5 mm	167,0 mm	83,5 mm	50 mm
53,0 mm	197,0 mm	98,5 mm	63 mm

# TECEflex – liitmikud

## Plastist kolmik üleminekuga PPSU

Diameeter	Tootekood	Kogus (pak. 1)	Kogus (pak. 2)	EUR/tk ilma KM
ø 16 x 20 x 16 mm	7 305 04	10 tk.	100 tk.	3,54
ø 20 x 16 x 16 mm	7 305 08	10 tk.	100 tk.	3,49
ø 20 x 16 x 20 mm	7 305 09	10 tk.	80 tk.	3,60
ø 20 x 20 x 16 mm	7 305 11	10 tk.	80 tk.	3,60

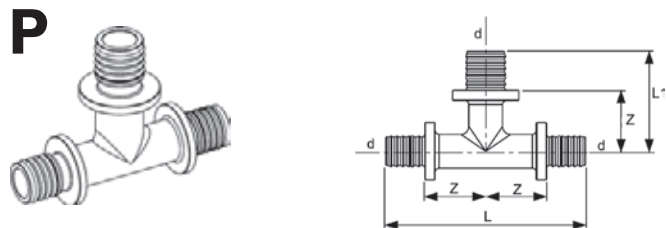

Z	Z1	Z2	L	L1	d	d1	d2
26,0 mm	26,0 mm	26,0 mm	81,6 mm	44,5 mm	16 mm	20 mm	16 mm
26,0 mm	26,0 mm	26,0 mm	84,3 mm	40,8 mm	20 mm	16 mm	16 mm
26,0 mm	26,0 mm	26,0 mm	87,0 mm	40,8 mm	20 mm	16 mm	20 mm
26,0 mm	26,0 mm	26,0 mm	84,3 mm	43,5 mm	20 mm	20 mm	16 mm

## Messingist kolmik üleminekuga

Diameeter	Tootekood	Kogus (pak. 1)	Kogus (pak. 2)	EUR/tk ilma KM
ø 16 x 20 x 16 mm	7 105 04	10 tk.	50 tk.	5,23
ø 20 x 16 x 16 mm	7 105 08	10 tk.	50 tk.	4,79
ø 20 x 16 x 20 mm	7 105 09	10 tk.	100 tk.	4,64
ø 20 x 20 x 16 mm	7 105 11	10 tk.	100 tk.	4,76
ø 25 x 16 x 16 mm	7 105 16	10 tk.	40 tk.	7,78
ø 25 x 16 x 20 mm	7 105 44	10 tk.	40 tk.	8,22
ø 25 x 16 x 25 mm	7 105 14	10 tk.	30 tk.	7,47
ø 25 x 20 x 20 mm	7 105 22	10 tk.	30 tk.	7,47
ø 25 x 20 x 25 mm	7 105 15	10 tk.	20 tk.	7,83
ø 20 x 25 x 20 mm	7 105 21	10 tk.	40 tk.	8,92
ø 25 x 32 x 25 mm	7 105 17	5 tk.	30 tk.	15,86
ø 32 x 16 x 32 mm	7 105 37	5 tk.	40 tk.	14,48
ø 32 x 20 x 25 mm	7 105 18	5 tk.	40 tk.	15,45
ø 32 x 20 x 32 mm	7 105 19	5 tk.	30 tk.	15,36
ø 32 x 25 x 25 mm	7 105 20	5 tk.	30 tk.	14,77
ø 32 x 25 x 32 mm	7 105 23	5 tk.	30 tk.	15,66
ø 40 x 20 x 40 mm	7 105 36	2 tk.	20 tk.	27,59
ø 40 x 25 x 32 mm	7 105 43	2 tk.	20 tk.	29,24
ø 40 x 25 x 40 mm	7 105 33	2 tk.	20 tk.	25,11
ø 40 x 32 x 40 mm	7 105 24	2 tk.	8 tk.	21,86
ø 40 x 32 x 32 mm	7 105 25	2 tk.	20 tk.	23,63
ø 50 x 20 x 50 mm	7 105 35	1 tk.	5 tk.	32,79
ø 50 x 25 x 40 mm	7 105 42	1 tk.	5 tk.	33,42
ø 50 x 25 x 50 mm	7 105 34	1 tk.	5 tk.	31,02
ø 50 x 32 x 50 mm	7 105 26	1 tk.	5 tk.	42,83
ø 50 x 40 x 40 mm	7 105 27	1 tk.	5 tk.	36,34
ø 50 x 40 x 50 mm	7 105 28	1 tk.	5 tk.	37,52
ø 63 x 25 x 63 mm	7 105 41	1 tk.	5 tk.	64,05
ø 63 x 32 x 63 mm	7 105 40	1 tk.	5 tk.	64,40
ø 63 x 40 x 63 mm	7 105 39	1 tk.	5 tk.	63,72
ø 63 x 50 x 63 mm	7 105 38	1 tk.	5 tk.	71,49

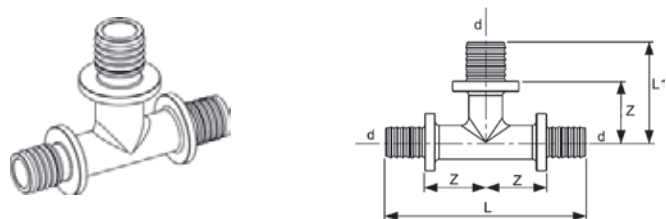

Z	Z1	Z2	L	L1	d	d1	d2
23,0 mm	25,0 mm	23,0 mm	79,6 mm	40,0 mm	16	20	16
23,0 mm	25,0 mm	23,0 mm	77,8 mm	39,8 mm	20	16	16
23,0 mm	25,0 mm	23,0 mm	80,0 mm	39,8 mm	20	16	20
25,0 mm	25,0 mm	25,0 mm	81,8 mm	42,0 mm	20	20	16
24,0 mm	28,0 mm	23,0 mm	85,8 mm	43,3 mm	25	16	16
24,0 mm	28,0 mm	23,0 mm	88,0 mm	44,0 mm	25	16	20
24,0 mm	28,0 mm	24,0 mm	96,0 mm	43,3 mm	25	16	25
25,0 mm	28,0 mm	25,0 mm	92,0 mm	45,5 mm	25	20	20
26,0 mm	28,0 mm	26,0 mm	100,0 mm	45,5 mm	25	20	25
29,0 mm	26,0 mm	29,0 mm	91,0 mm	50,0 mm	20	25	20
33,0 mm	30,0 mm	33,0 mm	114,0 mm	62,0 mm	25	32	25
25,0 mm	31,0 mm	28,0 mm	113,0 mm	47,0 mm	32	16	32
27,0 mm	26,0 mm	32,0 mm	109,0 mm	49,0 mm	32	20	25
27,0 mm	32,0 mm	27,0 mm	117,0 mm	49,0 mm	32	20	32
30,0 mm	33,0 mm	30,0 mm	115,5 mm	57,0 mm	32	25	25
36,0 mm	38,0 mm	36,0 mm	139,0 mm	68,5 mm	32	25	32
21,5 mm	34,5 mm	21,5 mm	125,0 mm	52,0 mm	40	20	40
31,0 mm	36,0 mm	30,0 mm	128,0 mm	60,0 mm	40	25	32
25,0 mm	34,5 mm	25,0 mm	132,0 mm	60,0 mm	40	25	40
37,0 mm	42,0 mm	37,0 mm	151,0 mm	73,5 mm	40	32	40
40,0 mm	43,0 mm	38,0 mm	151,0 mm	77,5 mm	40	32	32
32,0 mm	38,0 mm	32,0 mm	144,0 mm	65,0 mm	50	20	50
32,0 mm	41,0 mm	31,0 mm	138,0 mm	65,0 mm	50	25	40
32,0 mm	38,0 mm	32,0 mm	144,0 mm	65,0 mm	50	25	50
40,0 mm	41,0 mm	38,0 mm	151,0 mm	77,5 mm	50	32	50
38,0 mm	42,0 mm	38,0 mm	157,0 mm	77,5 mm	50	40	40
38,0 mm	38,0 mm	38,0 mm	137,0 mm	57,0 mm	50	40	50
52,0 mm	49,0 mm	52,0 mm	197,0 mm	73,0 mm	63	25	63
53,0 mm	49,5 mm	53,0 mm	197,0 mm	81,5 mm	63	32	63
53,0 mm	52,0 mm	53,0 mm	197,0 mm	81,5 mm	63	40	63
53,0 mm	53,0 mm	53,0 mm	197,0 mm	91,5 mm	63	50	63



## Plastkaitse kolmikule

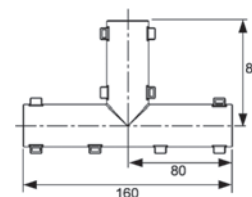

Diameeter	Tootekood	Kogus (pak. 1)	Kogus (pak. 2)	EUR/tk ilma KM
ø 16–20 mm	7 180 19	10 tk.	--	1,84

## Kaitsekarp ristuvale kolmikule



Diameeter	Tootekood	Kogus (pak. 1)	Kogus (pak. 2)	EUR/tk ilma KM
ø 16–20 mm	7 180 20	1 tk.	10 tk.	2,60

## Ristuv kolmik, nikeldatud

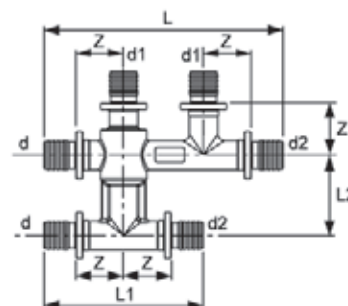
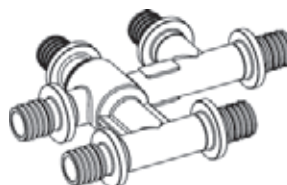

Diameeter	Tootekood	Kogus (pak. 1)	Kogus (pak. 2)	EUR/tk ilma KM	Z	L	L1	L2	d	d1	d2
ø 16 x 16 x 16 mm	7 185 01	1 tk.	10 tk.	25,70	23,0 mm	113,6 mm	75,5	38,0	16	16	16
ø 20 x 16 x 16 mm	7 185 02	1 tk.	10 tk.	27,77	23,0 mm	116,8 mm	79,8	40,0	20	16	16
ø 20 x 16 x 20 mm	7 185 03	1 tk.	10 tk.	28,95	23,0 mm	119,0 mm	82,0	40,0	20	16	20

# TECEflex – seinakannad

## Seinakand 90° sisekeermega

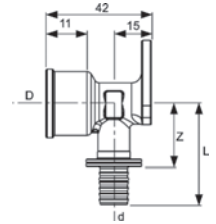

Diameeter	Tootekood	Kogus (pak. 1)	Kogus (pak. 2)	EUR/tk ilma KM	Z	L	D	d
∅ 16 mm x 1/2" SK	7 085 16	10 tk.	100 tk.	5,08	26,0 mm	41,0 mm	1/2" SK	16 mm
∅ 20 mm x 1/2" SK	7 085 20	10 tk.	50 tk.	6,62	26,0 mm	43,5 mm	1/2" SK	20 mm
∅ 20 mm x 3/4" SK	7 085 25	10 tk.	30 tk.	9,75	27,5 mm	45,0 mm	3/4" SK	20 mm
∅ 25 mm x 3/4" SK	7 085 26	10 tk.	20 tk.	10,16	30,0 mm	54,0 mm	3/4" SK	25 mm

## Heliisolatsiooni element

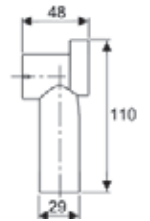

Diameeter	Tootekood	Kogus (pak. 1)	Kogus (pak. 2)	EUR/tk ilma KM
1/2" seinakannale	7 180 17	10 tk.	40 tk.	1,43

## Seinakand läbijooksuga 90°

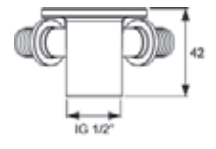
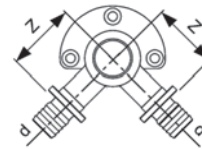

Diameeter	Toote- kood	Kogus (pak. 1)	Kogus (pak. 2)	EUR/tk ilma KM	Z	d
∅ 16 mm x 1/2" SK x 16 mm	7 085 01	10 tk.	30 tk.	9,48	33,0 mm	16

## Seinakand läbijooksuga 90° sisekeermega, väiksem rõhukadu

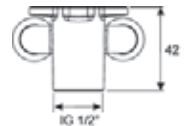
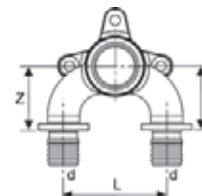

Diameeter	Toote- kood	Kogus (pak. 1)	Kogus (pak. 2)	EUR/tk ilma KM	Z	d	L
∅ 16 mm x 1/2" SK x 16 mm	7 085 04	10 tk.	30 tk.	22,69	33,0 mm	16	45,0
∅ 20 mm x 1/2" SK x 20 mm	7 085 05	10 tk.	30 tk.	28,18	33,0 mm	20	45,0

**Seinakand pikendusega 90° sisekeermega**

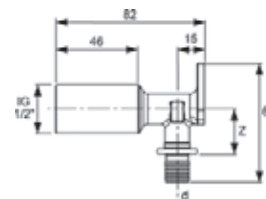
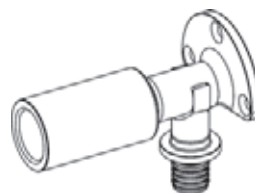

Diameeter	Tootekood	Kogus (pak. 1)	Kogus (pak. 2)	EUR/tk ilma KM	Z	d
ø 16 mm x 1/2" SK	7 085 02	10 tk.	20 tk.	7,53	33,0 mm	16

**Seinasisene messingist läbiviigupõlv 90° sisekeermega**

Vaheseina paigaldatav, seinapaksus 18-25mm

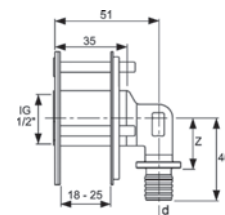
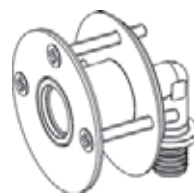

Diameeter	Tootekood	Kogus (pak. 1)	Kogus (pak. 2)	EUR/tk ilma KM	Z	d
ø 16 mm x 1/2" SK	7 087 01	10 tk.	20 tk.	11,23	25,0 mm	16

**Kinnituspõlv messingist 90° sisekeermega**

Vaheseina paigaldatav, seinapaksus 18-25mm

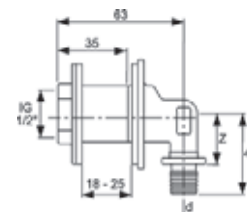
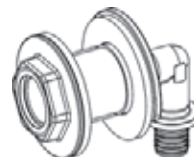

Diameeter	Tootekood	Kogus (pak. 1)	Kogus (pak. 2)	EUR/tk ilma KM	Z	d
ø 16 mm x 1/2" SK	7 087 02	10 tk.	20 tk.	12,11	25,0 mm	16

**Kinnituspõlv messingist 90° sisekeermega**

plastpaakidele

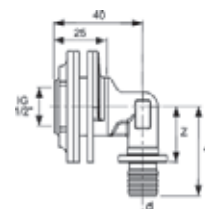
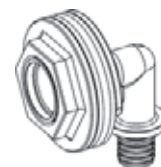

Diameeter	Tootekood	Kogus (pak. 1)	Kogus (pak. 2)	EUR/tk ilma KM	Z	d
ø 16 mm x 1/2" SK	7 086 01	10 tk.	40 tk.	9,16	25,0 mm	16

# TECEflex – kinnituskomplektid

## Montaazikomplekt seinakandade ja heliisolatsiooniga, sisekeermetega

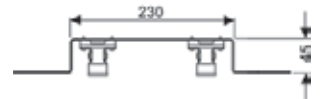
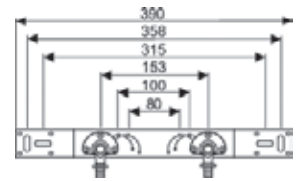
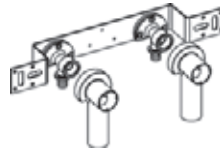

Diameeter	Tootekood	Kogus (pak. 1)	Kogus (pak. 2)	EUR/tk ilma KM
ø 16 mm x 1/2" SK	7 205 30	1 tk.	10 tk.	22,36

## Montaazikomplekt seinakandade ja heliisolatsiooniga, koos kanalipõlve kinnitusega

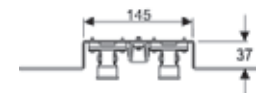
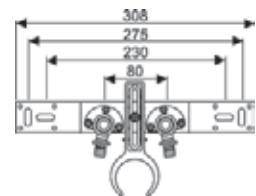
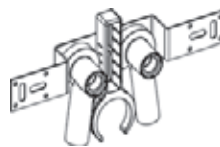

Diameeter	Tootekood	Kogus (pak. 1)	Kogus (pak. 2)	EUR/tk ilma KM
ø 16 mm x 1/2" SK	7 205 36	1 tk.	10 tk.	30,55

## Seinakannad kinnitusplaadil

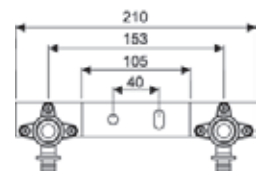
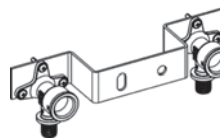

Diameeter	Tootekood	Kogus (pak. 1)	Kogus (pak. 2)	EUR/tk ilma KM
ø 16 mm x 1/2" SK	7 205 34	5 tk.	25 tk.	21,36

## Kinnitusplaat, tsingitud

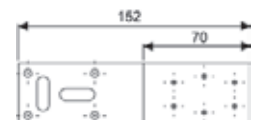
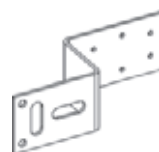

Kirjeldus	Tootekood	Kogus (pak. 1)	Kogus (pak. 2)	EUR/tk ilma KM
Kinnitusplaat	7 205 27	10 tk.	80 tk.	3,15

## Seinakanna kinnitusplaat, tsingitud

153/78 mm

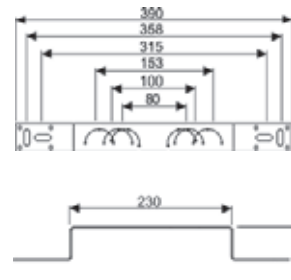

Kirjeldus	Tootekood	Kogus (pak. 1)	Kogus (pak. 2)	EUR/tk ilma KM
Kinnitusplaat	7 205 28	5 tk.	20 tk.	6,17

## TECEflex – jaotuskollektorid

Kollektorid on lihtsalt pikendatavad,

Näiteks: 2 haruga kollektor + 3 haruga kollektor = 5 haruga kollektor

### TECEflex kaheharuline messingist kollektor

Kollektori keermed 3/4"

Õhutusklapi keere 3/8"

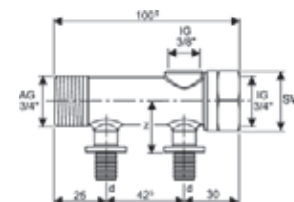
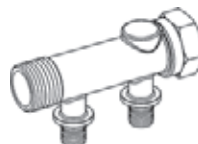

Diameeter	Tootekood	Kogus (pak. 1)	Kogus (pak. 2)	EUR/tk ilma KM	Z	SW	d
ø 16 mm 2 haru	7 120 07	1 tk.	12 tk.	15,95	28,0 mm	32,0 mm	16 mm

### TECEflex kolmeharuline messingist kollektor

Kollektori keermed 3/4"

Õhutusklapi keere 3/8"

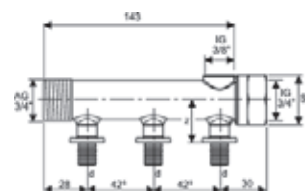
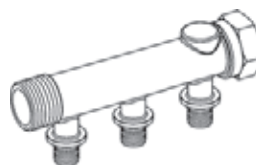

Diameeter	Tootekood	Kogus (pak. 1)	Kogus (pak. 2)	EUR/tk ilma KM	Z	SW	d
ø 16 mm 3 haru	7 120 08	1 tk.	10 tk.	18,91	28,0 mm	32,0 mm	16 mm

# TECEflex – adapterid

## TECEflex üleminek vasktorule

Üleminekuliitmik vasktorult TECEflex torule  
Joodetav

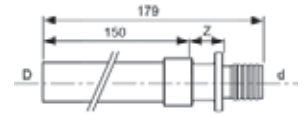
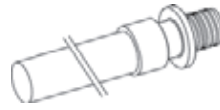

Diameeter	Vasktoru	Tootekood	Kogus (pak. 1)	Kogus (pak. 2)	EUR/tk ilma KM
ø 16 mm	ø 15 mm	7 138 16	5 tk.	100 tk.	6,65
ø 20 mm	ø 18 mm	7 138 20	5 tk.	40 tk.	7,53

Z	D	d
15,0 mm	15,0 mm	16,0 mm
15,0 mm	18,0 mm	20,0 mm

## Pronksist üleminek TECEflex torule

TECEflex pronksist üleminek, sobib vask- või roostevaba terastoru ühendamiseks. Sobib V või M tüüpi liitmikele.  
Joodetav

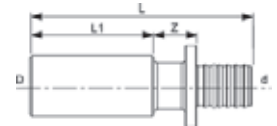
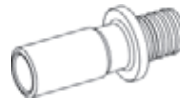

Diameeter	Vasktoru	Tootekood	Kogus (pak. 1)	Kogus (pak. 2)	EUR/tk ilma KM
ø 16 mm	ø 15 mm	7 163 16	10 tk.	150 tk.	4,29
ø 20 mm	ø 18 mm	7 163 20	10 tk.	100 tk.	6,07
ø 20 mm	ø 22 mm	7 163 21	10 tk.	100 tk.	5,29
ø 25 mm	ø 22 mm	7 163 25	10 tk.	50 tk.	8,24
ø 32 mm	ø 28 mm	7 163 32	10 tk.	50 tk.	10,86

Z	L	L1	D	d
12,0 mm	52,0 mm	25,0 mm	15,0 mm	16 mm
12,0 mm	54,0 mm	25,0 mm	18,0 mm	20 mm
12,0 mm	54,0 mm	25,0 mm	22,0 mm	20 mm
13,0 mm	62,0 mm	25,0 mm	22,0 mm	25 mm
13,0 mm	70,5 mm	25,0 mm	28,0 mm	25 mm

## TECEflex messingist üleminek vasktorule

Joodetav

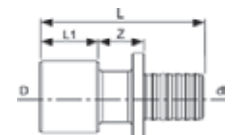
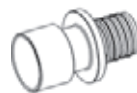

Diameeter	Vask muhv	Vasktoru	Toote- kood	Kogus (pak. 1)	Kogus (pak. 2)	EUR/tk ilma KM
ø 16 mm	ø 18 mm	ø 15 mm	7 139 16	10 tk.	150 tk.	1,98
ø 20 mm	ø 22 mm	ø 18 mm	7 139 20	10 tk.	100 tk.	3,37
ø 25 mm	ø 28 mm	ø 22 mm	7 139 25	10 tk.	50 tk.	5,97
ø 32 mm	ø 28 mm	ø 28 mm	7 139 32	5 tk.	40 tk.	10,58

Z	L	L1	D sidestus	D toru	d
12,0 mm	41,8 mm	15,0 mm	18,0 mm	15,0 mm	16 mm
12,0 mm	46,5 mm	17,0 mm	22,0 mm	18,0 mm	20 mm
13,0 mm	60,0 mm	23,0 mm	28,0 mm	22,0 mm	25 mm
14,0 mm	71,5 mm	26,0 mm	34,0 mm	28,0 mm	32 mm

**Üleminekuadapter**

**Pealekeeratava mutriga 3/4"SK ja eurokoonusega  
TECEflex süsteemi torudele, nikeldatud**

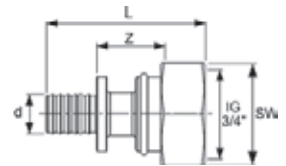
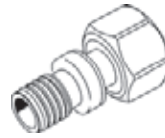

Diameeter	Tootekood	Kogus (pak. 1)	Kogus (pak. 2)	EUR/tk ilma KM	Z	SW	d	L
ø 16 mm	7 136 16 1	10 tk.	100 tk.	4,51	24,0 mm	30,0 mm	16 mm	47,0 mm

**Üleminekuadapter**

**Pealekeeratava mutriga 3/4"SK ja eurokoonusega  
TECEflex süsteemi torudele, messing**

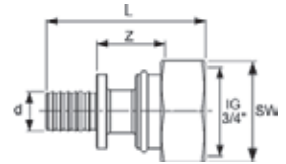
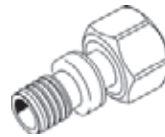

Diameeter	Tootekood	Kogus (pak. 1)	Kogus (pak. 2)	EUR/tk ilma KM	Z	L	SW	d
ø 16 mm	7 136 16	10 tk.	100 tk.	4,79	24,0 mm	47,3 mm	30,0 mm	16 mm
ø 20 mm	7 136 20	10 tk.	100 tk.	9,45	28,0 mm	52,9 mm	30,0 mm	20 mm

**TECEflex sisekeermega üleminek vabamutriga "amerikanka",  
messing**

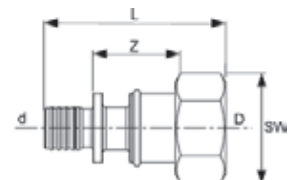

Diameeter	Tootekood	Kogus (pak. 1)	Kogus (pak. 2)	EUR/tk ilma KM	Z	L	SW	D	d
ø 16 mm x 1/2" SK	7 175 12	10 tk.	100 tk.	8,86	39,0 mm	57,3 mm	30,0 mm	1/2" SK	16 mm
ø 16 mm x 3/4" SK	7 175 07	10 tk.	100 tk.	8,86	39,0 mm	45,8 mm	30,0 mm	3/4" SK	16 mm
ø 20 mm x 3/4" SK	7 175 08	10 tk.	100 tk.	11,43	42,0 mm	51,5 mm	30,0 mm	3/4" SK	20 mm
ø 20 mm x 1" SK	7 175 14	5 tk.	50 tk.	8,12	42,0 mm	52,0 mm	38,0 mm	1" SK	20 mm
ø 25 mm x 1" SK	7 175 09	5 tk.	50 tk.	15,07	25,0 mm	63,0 mm	38,0 mm	1" SK	25 mm
ø 25 mm x 1 1/4" SK	7 175 15	5 tk.	30 tk.	13,29	25,0 mm	64,5 mm	46,0 mm	1 1/4" SK	25 mm
ø 32 mm x 1 1/4" SK	7 175 10	1 tk.	25 tk.	15,07	27,0 mm	74,5 mm	46,0 mm	1 1/4" SK	32 mm
ø 32 mm x 1 1/2" SK	7 175 16	1 tk.	15 tk.	18,91	27,0 mm	79,5 mm	52,0 mm	1 1/2" SK	32 mm
ø 40 mm x 1 1/2" SK	7 175 17	1 tk.	15 tk.	23,93	35,0 mm	88,5 mm	52,0 mm	1 1/2" SK	40 mm
ø 40 mm x 1 3/4" SK	7 175 18	1 tk.	10 tk.	27,47	35,0 mm	87,0 mm	59,0 mm	1 3/4" SK	40 mm
ø 50 mm x 1 3/4" SK	7 175 19	1 tk.	10 tk.	44,61	35,0 mm	91,5 mm	59,0 mm	1 3/4" SK	50 mm
ø 63 mm x 2 3/8" SK	7 175 20	1 tk.	5 tk.	98,96	36,0 mm	100,0 mm	74,0 mm	2 3/8" SK	63 mm

# TECEflex – adapterid

## Eurokoonusühendus PE-Xc ja PE-Xc 5S torudele 3/4"SK



Diameeter	Tootekood	Kogus (pak. 1)	Kogus (pak. 2)	EUR/tk ilma KM	d	SW
ø 16 mm	7 135 16	10 tk.	100 tk.	3,75	16	30,0 mm
ø 20 mm	7 130 20	10 tk.	100 tk.	4,58	20	30,0 mm

## Eurokoonus TECEflex mitmekihilistele torudele 3/4" sisekeere



Diameeter	Tootekood	Kogus (pak. 1)	Kogus (pak. 2)	EUR/tk ilma KM	d	SW
ø 16 mm	7 133 16	10 tk.	100 tk.	3,82	16	27,0 mm
ø 20 mm	7 133 20	10 tk.	100 tk.	4,28	20	27,0 mm

## Kalibraator TECEflex torudele

Kasutatakse keermesühendustega ühendamise korral



Diameeter	Tootekood	Kogus (pak. 1)	Kogus (pak. 2)	EUR/tk ilma KM
ø 16 mm	7 200 40	10 tk.	--	1,80



## TECEflex nikeldatud põlvliitmik radiaatoritele, 15mm

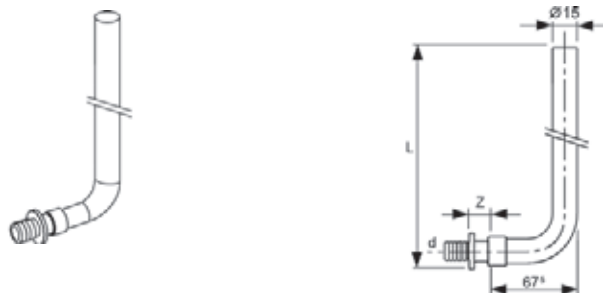

Diameeter	Tootekood	Kogus (pak. 1)	Kogus (pak. 2)	EUR/tk ilma KM
Ø 16 mm	7 140 16	10 tk.	50 tk.	9,01
Ø 20 mm	7 140 20	10 tk.	50 tk.	12,11
Ø 16 mm	7 145 16	6 tk.	60 tk.	22,45

Z	L	d
15,0 mm	330,0 mm	16
15,0 mm	330,0 mm	20
15,0 mm	1100,0 mm	16

## TECEflex nikeldatud T-väljavõte radiaatorile, 15mm



Diameeter	Tootekood	Kogus (pak. 1)	Kogus (pak. 2)	EUR/tk ilma KM
Ø 16 mm	7 150 16	10 tk.	--	12,31
Ø 20 mm	7 150 20	10 tk.	--	20,09

Z	d
44,0 mm	16
44,0 mm	20

## Radiaatori põlvliitmik isoleeritud, kinnitusega

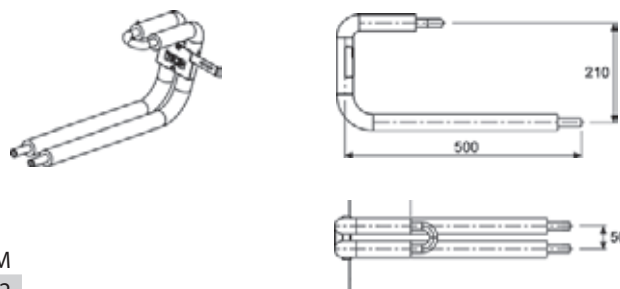

Diameeter	Tootekood	Kogus (pak. 1)	Kogus (pak. 2)	EUR/tk ilma KM
Ø 16 mm	7 149 07	1 tk.	5 tk.	17,62

## Radiaatori põlvliitmik isoleeritud, kinnitusega

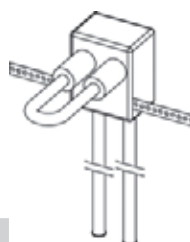

Diameeter	Tootekood	Kogus (pak. 1)	Kogus (pak. 2)	EUR/tk ilma KM
Ø 16 mm	7 162 16	1 tk.	5 tk.	24,48

# TECEflex – radiaatorite ühendustarvikud

## Ühendus VK tüüpi radiaatoritele Nikeldatud.

Telgede vaheline kaugus 50 mm

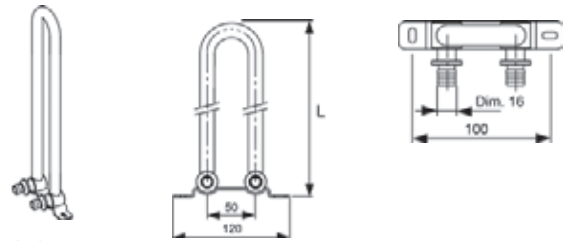

Diameeter	Pikkus L mm	Tootekood	Kogus (pak. 1)	Kogus (pak. 2)	EUR/tk ilma KM
ø 16 mm	300	7 149 01	1 tk.	10 tk.	28,95

## Ühendus VK tüüpi radiaatoritele Nikeldatud.

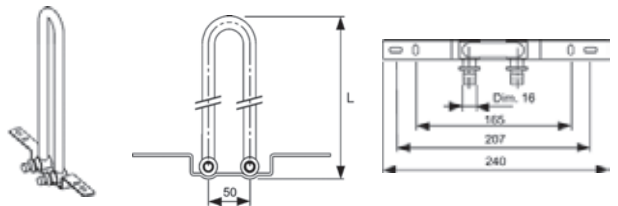

Diameeter	Pikkus L mm	Tootekood	Kogus (pak. 1)	Kogus (pak. 2)	EUR/tk ilma KM
ø 16 mm	300	7 149 05	1 tk.	10 tk.	22,89

## Tarvikukomplekt VK tüüpi radiaatorite ühendamiseks 16 x 1/2"SK

Ühendatakse põrandaliistuste süsteemi põlvliitmikuga (Tootek. 730010) ja (Tootek. 717501) Qutech tüüpi ühendus

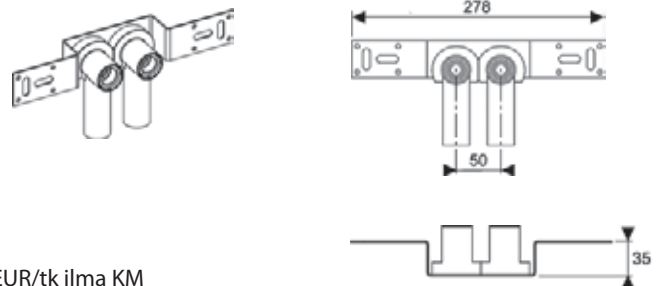

Diameeter	Tootekood	Kogus (pak. 1)	Kogus (pak. 2)	EUR/tk ilma KM
ø 16 mm x 1/2" SK	7 205 37	1 tk.	5 tk.	24,81

## Qutech tüüpi keermesühendus

Monteerimis põlvede ja kolmikute ühendamiseks radiaatorite külge, vastavalt standardile DIN EN 215

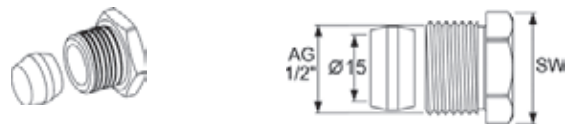

Diameeter	Tootekood	Kogus (pak. 1)	Kogus (pak. 2)	EUR/tk ilma KM
ø 15 mm x 1/2" VK	7 175 01	10 tk.	150 tk.	2,32

## Ühene toruhoidik

Sobib torudele 16–20 mm



Diameeter	Tootekood	Kogus (pak. 1)	Kogus (pak. 2)	EUR/tk ilma KM
Kõrgus 60 mm	7 205 21	30 tk.	600 tk.	0,25
Kõrgus 100 mm	7 205 01	30 tk.	450 tk.	0,22

L	L1
60,0 mm	25,0 mm
100,0 mm	65,0 mm

## Kahene toruhoidik

Sobib torudele 16–20 mm

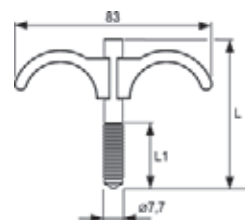

Diameeter	Tootekood	Kogus (pak. 1)	Kogus (pak. 2)	EUR/tk ilma KM
Kõrgus 60 mm	7 205 22	30 tk.	450 tk.	0,31
Kõrgus 100 mm	7 205 02	30 tk.	300 tk.	0,25

L	L1
60,0 mm	25,0 mm
100,0 mm	65,0 mm

## Plastpõlv TECEflex torudele radiaatorite ühendamiseks põrandast

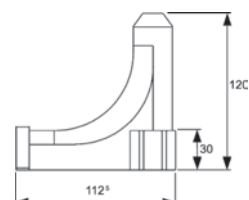

Diameeter	Tootekood	Kogus (pak. 1)	Kogus (pak. 2)	EUR/tk ilma KM
16 mm	7 180 05	5 tk.	20 tk.	2,80

# TECEflex – radiaatorite ühendustarvikud

## Põrandaliistuste pölvliitmik

15 mm nikeldatud vasest TECEflex süsteemile

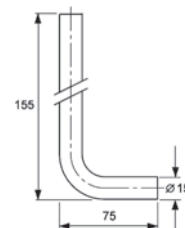

Diameeter	Tootekood	Kogus (pak. 1)	Kogus (pak. 2)	EUR/tk ilma KM
ø 15 mm	7 300 25	1 kompl. (2 tk.)	20 kompl.	8,83

## Reguleeritava ventiiliga pölvliitmik põrandaliistuste süsteemile

15 mm nikeldatud vasest reguleeritava ventiiliga TECEflex süsteemile

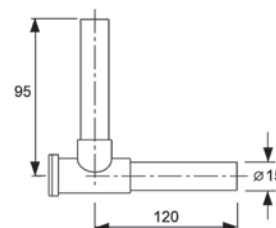
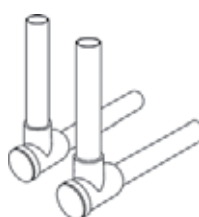

Diameeter	Tootekood	Kogus (pak. 1)	Kogus (pak. 2)	EUR/tk ilma KM
ø 15 mm	7 300 10	1 kompl. (2 tk.)	20 kompl.	26,39

# TECEflex – radiaatorite ühendussõlmed

## Nikeldatud vasest radiaatori ühendus TECEflex toru süsteemile

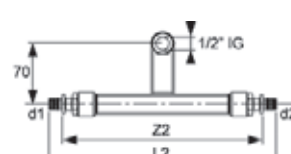
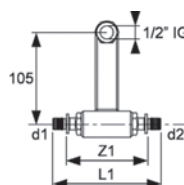

Diameeter	Tootekood	Kogus (pak. 1)	Kogus (pak. 2)	EUR/tk ilma KM	Z1	Z2	L1	L2	d1	d2
ø 16 mm x 15 Cu x ø 16 mm	7 301 10	1 kompl. (2 tk.)	10 kompl.	74,38	93,0 mm	229,0	124,0 mm	260,0 mm	16	16
ø 20 mm x 15 Cu x ø 20 mm	7 301 15	1 kompl. (2 tk.)	10 kompl.	74,38	93,0 mm	229,0	128,0 mm	264,0 mm	20	20
ø 16 mm x 15 Cu x ø 16 mm	7 301 20	1 kompl. (2 tk.)	10 kompl.	74,38	93,0 mm	229,0	126,0 mm	262,0 mm	20	16
ø 20 mm x 15 Cu x ø 20 mm	7 301 25	1 kompl. (2 tk.)	10 kompl.	74,38	93,0 mm	229,0	126,0 mm	262,0 mm	16	20
ø 16 mm x 15 Cu x kork	7 301 30	1 kompl. (2 tk.)	10 kompl.	67,92	--	--	117,0 mm	252,0 mm	16	kork
ø kork x 15 Cu x ø 16 mm	7 301 35	1 kompl. (2 tk.)	10 kompl.	74,38	--	--	117,0 mm	252,0 mm	kork	16

**Mehaaniline toruotsa laiendamise tööriist RAZ-V**

TECEflex süsteemi torudele mõõduga 16–32 mm

- Komplektne tööriist kohvriss
- Laiendusotsikud 16-32 mm

Diameeter	Tootekood	Kogus (pak. 1)	Kogus (pak. 2)	EUR/tk ilma KM
Ø 16–32 mm	7 200 56	1 tk.	--	220,11

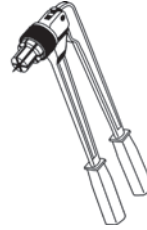
**Mehaaniline surverõngaste press HPW-L**

TECEflex süsteemi torudele mõõduga 16–32 mm

- Komplektne tööriist kohvriga
- Tõmbehaaratsid 16-32 mm

Diameeter	Tootekood	Kogus (pak. 1)	Kogus (pak. 2)	EUR/tk ilma KM
Ø 16–32 mm	7 200 50	1 tk.	--	272,24

**Toruotsa laiendusseade akuga RazFaz**

Lihtne kasutada toruotsa laiendamiseks mõõtudele 16-32mm

- RazFaz akuga tööriist
- 16–32 mm tõmbehaaratsid
- Võimas NiMH aku
- Akulaadija
- Kast tööriistale

Diameeter	Tootekood	Kogus (pak. 1)	Kogus (pak. 2)	EUR/tk ilma KM
Ø 16–32 mm	7 201 72	1 tk.	--	984,71

**Surverõngaste press-seade akuga RazFaz**

Lihtne kasutada surverõngaste kokkutõmbamiseks mõõtudele 16-32mm

- RazFaz tööriist
- Tõmbehaaratsid 16–20 mm ja 25–32 mm
- Võimas NiMH aku
- Akulaadija
- Kast tööriistale

Diameeter	Tootekood	Kogus (pak. 1)	Kogus (pak. 2)	EUR/tk ilma KM
Ø 16–32 mm	7 201 73	1 tk.	--	1129,52



# TECEflex – tööriistad

## RazFaz seadmete komplekt

Komplektis:

- Razfaz akuga laiendusseade
- Razfaz akuga kokkusurumisseade
- Laiendusotsikud 16–32 mm
- Tõmbehaaratsid 14/16–20 mm ja 25–32 mm
- 2 akut
- Akulaadija
- Tööriistakast



Diameeter	Tootekood	Kogus (pak. 1)	Kogus (pak. 2)	EUR/tk ilma KM
Ø 16–32 mm	7 201 74	1 kompl.	--	1898,46

## RazFaz seadme aku 3.0 Ah

Tootekood	Kogus (pak. 1)	Kogus (pak. 2)	EUR/tk ilma KM
7 201 75	1 tk.	--	109,19



## RazFaz seadme ühendus 220V pingega

Tootekood	Kogus (pak. 1)	Kogus (pak. 2)	EUR/tk ilma KM
7 201 76	1 tk.	--	195,49



**Surverõngaste press-seade PMA 14 40**

Press-seade TECEflex surverõngaste 16-32mm kokkusurumiseks.  
Vajalik standardne 32Kn elektriseadme olemasolu töö tegemiseks

Komplektis:

- PMA 16 40 tööriistapea
- 16–32 mm tõmbehaaratsid

Tööriista saab kohandada ka 40mm haaratsitega

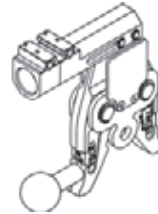

Diameeter	Tootekood	Kogus (pak. 1)	Kogus (pak. 2)	EUR/tk ilma KM
ø 16–32 mm	7 201 80	1 kompl.	--	550,28

**40 mm press-seadme haaratsid  
PMA 14 40 press-seadmele**

Diameeter	Tootekood	Kogus (pak. 1)	Kogus (pak. 2)	EUR/tk ilma KM
ø 40 mm	7 201 85	1 kompl.	--	118,74

**Laiendusotsik PMA 14 40 tööriistale**

Mehaaniliseks 40mm TECEflex toruotsa laiendamiseks  
Sobib PMA 14 40 tööriistale

Komplektis:

- Laiendusotsik tööriistale PMA 14 40
- 40 mm laiendusotsik

Alternatiivina saab kasutada ka RAZ-V 7 200 56 tööriista  
laiendusotsikuid

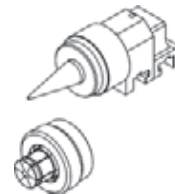

Diameeter	Tootekood	Kogus (pak. 1)	Kogus (pak. 2)	EUR/tk ilma KM
ø 16–40	7 201 90	1 kompl.	--	217,22

# TECEflex – tööriistad

## Surverõngaste press-seade PMA 40 63( laiendamiseks ja kokkusurumiseks)

Press-seade TECEflex surverõngaste 40-63mm laiendamiseks ja kokkusurumiseks. Vajalik standardne 32Kn elektriseadme olemasolu töö tegemiseks

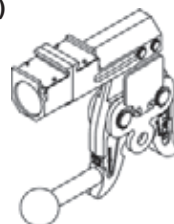

Komplektis:

- PMA 40 63 tööriista otsik
- 40–63 mm kinnitõmbehaaratsid
- AWS 40 63 tööriista pea pressmasinale
- 40–63 mm laiendusotsikud
- tööriistakast

Diameeter	Tootekood	Kogus (pak. 1)	Kogus (pak. 2)	EUR/tk ilma KM
∅ 40–63 mm	7 201 70	1 kompl.	--	1449,55

## Laiendusotsik AWS 40-63 tööriistapeale

TECEflex torudele 25 mm ja 32 mm



Diameeter	Tootekood	Kogus (pak. 1)	Kogus (pak. 2)	EUR/tk ilma KM
∅ 25 ja 32 mm	7 201 28	1 tk.	--	179,56



**Torukäärid**

Diameeter	Tootekood	Kogus (pak. 1)	Kogus (pak. 2)	EUR/tk ilma KM
∅ 16–25 mm	7 200 05	1 tk.	--	18,83
∅ 16–40 mm	7 200 93	1tk.	--	36,20

**Kofreeritud toru lõikamise käärid**

Diameeter	Tootekood	Kogus (pak. 1)	Kogus (pak. 2)	EUR/tk ilma KM
∅ 16–25 mm	7 200 90	1 tk.	--	44,01

**Torulõikur**

Diameeter	Tootekood	Kogus (pak. 1)	Kogus (pak. 2)	EUR/tk ilma KM
16–63	876 00 08	1 tk.	--	72,41
Varutera	876 00 09	1 tk.	--	11,58

**Toru lahtirullimisalus**

Kokkupandav, reguleeritav, toru rullile kuni 600m.

Tootekood	Kogus (pak. 1)	Kogus (pak. 2)	EUR/tk ilma KM
7 201 93	1 tk.	--	231,70

**Toru sirgendamise seade**

Torude 16 mm ja 20 mm sirgendamiseks



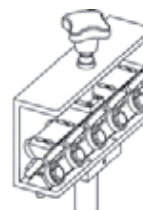



Diameeter	Tootekood	Kogus (pak. 1)	Kogus (pak. 2)	EUR/tk ilma KM
∅ 16 mm ja 20 mm	7 201 94	1 tk.	--	202,73

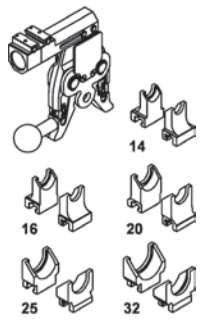

## TECEflex tööriistade ülevaade: toruotsa laiendamine

	Mehaaniline laiendaja	Akuga laiendusseade	Laiendus ja press-otsikud pressmasinatele	
	<p>RAZ-V</p>		<p>(Tootekood 7 201 80)</p> <p>+ laienduskomplekt (Tootekood 7 201 90)</p> <p>+ RAZ-V laiendusotsikud</p>	<p>PMA 40 63 (Tootekood 7 201 70)</p> <p>+ laiendusotsik 25–32 (Tootekood 7 201 28)</p>
Diaameeter				
ø 16 mm	✓	✓	✓	-
ø 20 mm	✓	✓	✓	-
ø 25 mm	✓	✓	✓	✓
ø 32 mm	✓	✓	✓	✓
ø 40 mm	-	-	✓	✓
ø 50 mm	-	-	-	✓
ø 63 mm	-	-	-	✓

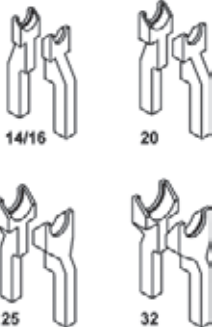
## TECEflex press-seadmed:

	Mehaaniline press HPW-L	Akuga press	Laiendus – ja pressotsikud pressmasinatele	
			PMA 14 40 (Tootekood. 7 201 80)	PMA 40 63 (Tootekood 7 201 70)
				
			+ haaratsid (Tootekood 7 201 85) 	
Diameeter				
ø 16 mm	✓	✓	✓	–
ø 20 mm	✓	✓	✓	–
ø 25 mm	✓	✓	✓	–
ø 32 mm	✓	✓	✓	✓
ø 40 mm	–	–	✓	✓
ø 50 mm	–	–	–	✓
ø 63 mm	–	–	–	✓

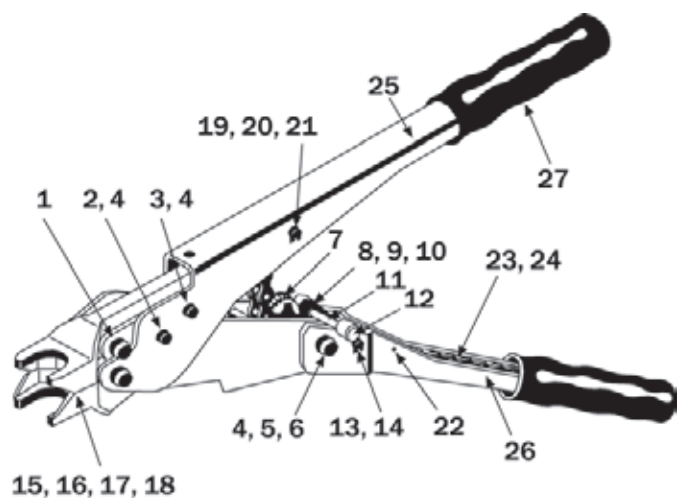

## TECEflex

### Mehaaniline press HPW-L (7 200 50)

Nr.	Kood.	Kirjeldus
1	7 200 64	Haaratsite fikseerimispoldid
2	7 200 48	Vedruseibiga keskpolt
3	7 200 72	Vedruseibiga kahvli kinnituspolt
4	7 200 96	Kahvelühenduse lukustusrõngas
5	7 201 69	Hammasratta vaherõngas
6	7 200 97	Hammasratta polt
7	7 201 58	Hammasratas
8	7 200 69	Hammasratta stopper
9	7 200 60	Stopperi vedru
10	7 201 10	Stopper
11	7 201 65	Stopperi spindel
12	7 201 66	Kork
13	7 201 60	Polt
14	7 201 68	Vaherõngas
15	7 200 61	Haaratsid 14/16 mm
16	7 200 62	Haaratsid 20 mm
17	7 200 63	Haaratsid 25 mm
18	7 200 79	Haaratsid 32 mm
19	7 200 66	Keti kinnitusneet
20	7 200 67	Lukustusrõngas kinitusneedile
21	7 201 61	Vaherõngas
22	7 201 62	Vedruneeet
23	7 201 02	Kett
24	7 200 91	Keti pinguti
-	7 201 15	Üleminek vedru pingutist (kuni 06.2001) stopperi vedrule (alates 07.2001)
25	7 201 57	Käepide pikk
26	7 201 56	Käepide lühike
27	7 201 53	Käepideme kaitse

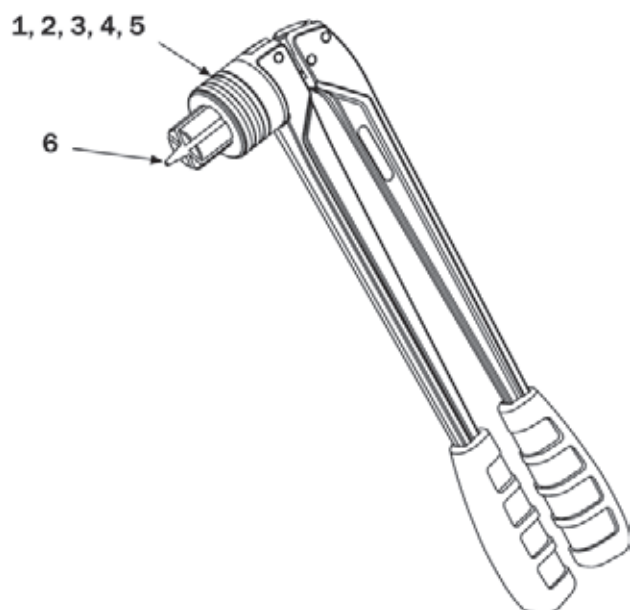
**Mehaaniline toruotsa laiendaja RAZ-V (7 200 56)**

Nr.	Kood.	Kirjeldus
1	7 200 41	Laiendusotsik V 14 mm
2	7 200 42	Laiendusotsik V 16 mm
3	7 200 43	Laiendusotsik V 20 mm
4	7 200 45	Laiendusotsik V 25 mm
5	7 200 46	Laiendusotsik V 32 mm
6	7 200 95	RAZ-V spindel

# TECE – projekteerimistarkvara

**Komplektne tarkvara InstalSystem-TECE Baltikum on mõeldud projekteerijatele, disaineritele aga ka hooldusteenuse pakkujatele.**

Pakett sisaldab:

- Õppematerjalid.
- Küttesüsteemide projekteerimise osa Instal-therm.
- Soojakadude arvutamise programm Instal-heat&energy.
- Sanitaartechnilise disaini osa Instal-san.

## Programmide eesmärk ja võimalused

### Instal – therm

See on põranda- ja seinakütte ning radiaatorkütte (ühe toru, kahe toru ja kollektoritega) projekteerimistarkvara. Vastavalt etteantud andmetele arvutatakse hüdro süsteem, valitakse automaatselt toru mõõdud ja radiaatorid, ventiilid jne. Tulemuseks on valmis projekt, koos täieliku kirjelduse ja spetsifikatsiooniga.

### Instal-heat&energy

Programm **Instal-heat&energy** on tihedalt seotud programmiga **InstalSystem-TECE Baltikum**. Seda kasutatakse soojuskao arvutusteks projekteeritud või ehitatud hoonetes. Madalaim temperatuur valitakse vastavalt Eesti ilmajaamadele.

Valmis joonised on ühised mõlemas programmis (**Instal-heat&energy ja Instal-therm**). Soojuskao arvutatakse **Instal-heat&energy** programmi abil ja tulemused salvestatakse faili, mida saab seejärel kasutada radiaator – ja põrandakütte tehniliste parameetrite arvutamiseks.

AutoCAD programmi joonised DWG või DXF faili kujul, saab importida **Instal-therm** programmi ja seejärel teha soojuskao arvutused **Instal-heat&energy** programmis. Seejärel saab joonised jälle AutoCAD programmi tagasi tõsta.

### Instal-san

Programm **Instal-san** kuuma –ja külma tarbevee süsteemide projekteerimiseks. Sisestades programmi andmed joonistab programm automaatselt torustike paigalduse skeemi. Seejärel saab teha hüdraulika ja muud süsteemielementide arvutused.

<b>Nimi</b>	300 EUR/ tk ilma KM
Instal – therm/heat&energy	175 EUR/ tk ilma KM
Instal-san	125 EUR/ tk ilma KM



TECElogo

**TECE**logo  
**Hinnakiri 2013**

**TECE:**  
Intelligente Haustechnik

# TECElogo – tootekirjeldus

## TECElogo torustikud - süsteem professionaalidele

### TECElogo torud:

PE-Xc torude töötemperatuur kuni 90 °C  
Toru PE-Xc sisekiht tagab pika eluea isegi 90 °C temperatuuril. Toru kasutamisaala on väga mitmekülgne.

Mitmekihilise PE-RT toru töötemperatuur 70 °C  
Ideaalne kasutamiseks madala temperatuuriga küttesüsteemides ja veetorustikena, kus temperatuur ei ületa 70 °C. Kui süsteemis on kõrgem temperatuur, siis see vähendab toru eluiga. Sel juhul soovitame paigaldada PE-Xc mitmekihilist toru. Mõlemat tüüpi torul on sisekiht kaetud 100% hapnikukindla alumiiniumist kaitsekihiga, mis on kokku sulatatud elektronkiire meetodil. Tänu kõrgtehnoloogilistele materjalidele ja tehnoloogiale on TECElogo torusüsteeme mugav ja lihtne paigaldada



### TECElogo ühendused:

Töövõtted on lihtsad: lõika, kalibreeri, lükka toru liitmikku ja ongi valmis. TECElogo liitmike süsteem ei vaja kalleid ja hooldust vajavaid profitööriistu. Toru lükatakse liitmikku ja liitmik on veetihe, ning kannatab suuri koormusi. Spetsiaalse võtmega on võimalik liitmikku avada ja see võimaldab liitmikku uuesti kasutada.



DW-8501BT0526



### TECElogo liitmikud:

TECElogo liitmikud on kompaktsed. Koosnevad kolmest plastosat ja kummitihenditest. Santehniliste ja küttesüsteemide jaoks pakutakse messingist ja polüfenüülsulfoonist PPSU liitmike. Need materjalid on mehhaaniliselt väga vastupidavad ja hügieeni seisukohast täiesti laitmatud. TECElogo liitmikud on universaalsed ja sobivad nii kütteki veevarustussüsteemidele.

### TECElogo sortiment

TECElogo valikus on olemas kõik materjalid vee-, radiaatorkütte- ja põrandakütte süsteemidele mõeldud vahemikus 16-50mm.







	Lehekülg
TECElogo mitmekihilised torud	42
TECElogo liitmikud	43
TECElogo seinaliitmikud	48
TECElogo paigaldusdetailid ja jaotuskollektorid	49
TECElogo adapterid	50
TECElogo radiaatori ühendused	51
TECElogo tööriistad	54
Projekteerimistarkvara	56

TECElogo liitmikke soovitame kasutada ainult TECElogo torudega. TECElogo süsteemile kehtib garantii ainult TECE komponentide kasutamisel. TECElogo liitmikke soovitame paigaldada ainult TECElogo tööriistadega.

# TECElogo – TECElogo mitmekihilised torud

## TECElogo mitmekihilised torud joogiveele ja küttele

TECElogo mitmekihiline toru ühendab endas metalltorude ja plasttorude parimaid omadusi. TECElogo torusid on kerge painutada, kuid samas ei kaota nad oma jäikust. Torude sisekiht on kas PE-Xc või PE-RT materjalist, ning on kaetud 100% hapnikukindla alumiiniumiga.

## TECElogo PE-Xc mitmekihilised torud

Paigaldusklass DIN EN ISO 15875-1:

Klass 2, Joogivesi: Töötemperatuur 70 °C, maksimaalne temperatuur 80 °C, pidev töö rõhk 10 bar, maksimaalne lühiajaline kiireloomuline temperatuur 95 °C maks. 100 h.

Klass 5, Küttesüsteemid: Töötemperatuur 80 °C, maksimaalne temperatuur 90 °C, töö rõhk 10 bar, maksimaalne lühiajaline kiireloomuline temperatuur 100 °C maks. 150 h.

## PE-Xc mitmekihiline toru

Mitmekihiline alumiiniumiga joogivee ja küttesüsteemide toru, pealmine kiht valge PE

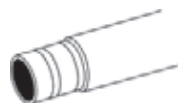

Diameeter	Tootekood	Kogus (pak. 1)	Kogus (pak. 2)	Kogus (pak. 3)	EUR/jm ilma KM
ø 16 - Rull	870 00 16	100 m	1000 m	2000 m	1,21
ø 18 - Rull	870 00 18	200 m	700 m	1400 m	1,51
ø 20 - Rull	870 00 20	100 m	700 m	1400 m	1,65
ø 25 - Rull	870 00 25	50 m	350 m	700 m	3,10
ø 16 - Latt	870 01 16	100 m	--	--	1,74
ø 20 - Latt	870 01 20	70 m	--	--	2,32
ø 25 - Latt	870 01 25	45 m	--	--	3,77
ø 32 - Latt	870 01 32	30 m	--	--	6,95
ø 40 - Latt	870 01 40	15 m	--	--	13,47
ø 50 - Latt	870 01 50	15 m	--	--	24,85

(Latis toru pikkus 5 m)

## TECElogo PE-RT mitmekihiline toru

Paigaldusklass DIN EN ISO 15875-1:

Klass 2, Joogivesi: Maksimaalne temperatuur 70 °C, maksimaalne töö rõhk 10 bar, maksimaalne lühiajaline kiireloomuline temperatuur 95 °C maks. 100 h. Klass 5, Küttesüsteemid: Maksimaalne temperatuur 80 °C, maksimaalne töö rõhk 10 bar, maksimaalne lühiajaline kiireloomuline temperatuur 95 °C maks. 100h.

## PE-RT mitmekihiline toru

Mitmekihiline alumiiniumiga joogivee ja küttesüsteemide toru, pealmine kiht valge PE

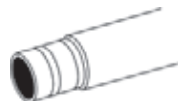

Diameeter	Tootekood	Kogus (pak. 1)	Kogus (pak. 2)	Kogus (pak. 3)	EUR/jm ilma KM
ø 16 - Rull	870 50 16	100 m	1000 m	2000 m	1,00
ø 18 - Rull	870 50 18	200 m	700 m	1400 m	1,28
ø 20 - Rull	870 50 20	100 m	700 m	1400 m	1,51
ø 25 - Rull	870 50 25	50 m	350 m	700 m	2,46
ø 16 - Latt	870 51 16	100 m	--	--	1,48
ø 20 - Latt	870 51 20	70 m	--	--	1,97
ø 25 - Latt	870 51 25	45 m	--	--	3,20

(Latis toru pikkus 5 m)

Liitmikud on valmistatud messingist ja polüfenüülsulfoonist (PPSU) ja sobivad nii vee- kui ka küttesüsteemidele. PPSU on mehhaniliselt väga tugev ja löögikindel materjal mida soovitab Saksa Gaasi- ja Veetehnika Teaduskeskuse Assotsiatsioon (DVGW) joogivee paigaldistesse. PPSU liitmikud on korrosioonikindlad ja hügieeni seisukohast täiesti laitmatud. Keermesliitmike korpused on tehtud kvaliteetsest messingist, mis sobib ka hästi joogiveele.

## Üleminekumuhv sisekeermega

Liitmiku korpus messing

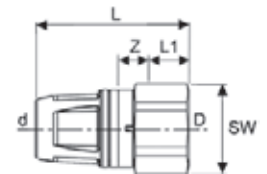

Diameeter	Tootekood	Kogus (pak. 1)	Kogus (pak. 2)	EUR/tk ilma KM	Z	L	L1	D	d	SW
ø 16 mm x 1/2" SK	871 00 02	10 tk.	100 tk.	3,55	8,5 mm	50,0 mm	15,0 mm	1/2" SK	16	27
ø 20 mm x 1/2" SK	871 00 03	10 tk.	100 tk.	4,50	8,5 mm	55,0 mm	15,0 mm	1/2" SK	20	27
ø 20 mm x 3/4" SK	871 00 04	10 tk.	80 tk.	5,21	8,7 mm	56,5 mm	16,3 mm	3/4" SK	20	32
ø 25 mm x 3/4" SK	871 00 05	10 tk.	50 tk.	7,49	8,7 mm	59,5 mm	16,3 mm	3/4" SK	25	32
ø 25 mm x 1" SK	871 00 06	5 tk.	50 tk.	9,59	10,4 mm	63,0 mm	19,1 mm	1" SK	25	40
ø 32 mm x 1" SK	871 00 07	1 tk.	20 tk.	12,16	17,8 mm	82,2 mm	19,1 mm	1" SK	32	40
ø 40 mm x 1 1/2" SK	871 00 08	1 tk.	20 tk.	30,87	20,5 mm	89,2 mm	21,4 mm	1 1/2" SK	40	56
ø 50 mm x 2" SK	871 00 09	1 tk.	8 tk.	50,36	21,2 mm	94,2 mm	25,7 mm	2" SK	50	69

## Üleminekunippel väliskeermega

Liitmiku korpus messing

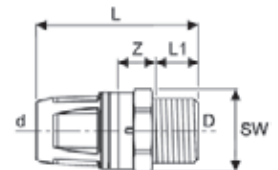

Diameeter	Tootekood	Kogus (pak. 1)	Kogus (pak. 2)	EUR/tk ilma KM	Z	L	L1	D	d	SW
ø 16 mm x 1/2" VK	871 01 02	10 tk.	100 tk.	2,97	13,3 mm	53,0 mm	13,2 mm	1/2" VK	16	24
ø 16 mm x 3/4" VK	871 01 03	10 tk.	100 tk.	4,50	13,3 mm	54,3 mm	13,2 mm	3/4" VK	16	24
ø 20 mm x 1/2" VK	871 01 04	10 tk.	80 tk.	4,50	13,3 mm	58,0 mm	13,2 mm	1/2" VK	20	29
ø 20 mm x 3/4" VK	871 01 05	10 tk.	50 tk.	4,95	13,3 mm	59,3 mm	14,5 mm	3/4" VK	20	29
ø 25 mm x 3/4" VK	871 01 06	10 tk.	50 tk.	8,33	13,3 mm	62,3 mm	14,5 mm	3/4" VK	25	34
ø 25 mm x 1" VK	871 01 07	10 tk.	50 tk.	9,59	13,3 mm	65,1 mm	16,8 mm	1" VK	25	34
ø 32 mm x 1" VK	871 01 16	1 tk.	20 tk.	11,41	25,2 mm	87,3 mm	16,8 mm	1" VK	32	34
ø 40 mm x 1 1/4" VK	871 01 17	1 tk.	20 tk.	27,88	25,3 mm	91,7 mm	19,1 mm	1 1/4" VK	40	43
ø 50 mm x 1 1/2" VK	871 01 18	1 tk.	8 tk.	47,36	27,8 mm	94,2 mm	19,1 mm	1 1/2" VK	50	48

# TECElogo – liitmikud

**P**

## Jätkumuhv PPSU

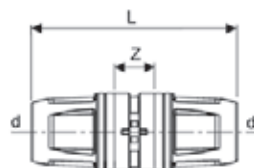

Diameeter	Tootekood	Kogus (pak. 1)	Kogus (pak. 2)	EUR/tk ilma KM
∅ 16 x 16 mm	871 05 16	10 tk.	80 tk.	3,42
∅ 20 x 20 mm	871 05 20	10 tk.	80 tk.	4,90
∅ 25 x 25 mm	871 05 25	10 tk.	80 tk.	6,66
∅ 32 x 32 mm	871 05 32	1 tk.	20 tk.	12,53
∅ 40 x 40 mm	871 05 40	1 tk.	20 tk.	20,86
∅ 50 x 50 mm	871 05 50	1 tk.	8 tk.	32,04

Z	L	d
14,0 mm	67,0 mm	16 mm
14,0 mm	77,0 mm	20 mm
14,0 mm	83,0 mm	25 mm
26,7 mm	117,3 mm	32 mm
27,3 mm	121,9 mm	40 mm
27,8 mm	122,4 mm	50 mm

**P**

## Üleminekumuhv PPSU

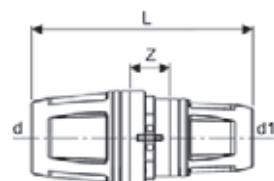

Diameeter	Tootekood	Kogus (pak. 1)	Kogus (pak. 2)	EUR/tk ilma KM
∅ 20 x 16 mm	871 06 16	10 tk.	80 tk.	4,35
∅ 25 x 16 mm	871 06 20	10 tk.	80 tk.	5,36
∅ 25 x 20 mm	871 06 25	10 tk.	80 tk.	5,63
∅ 32 x 20 mm	871 06 32	1 tk.	20 tk.	10,19
∅ 32 x 25 mm	871 06 33	1 tk.	20 tk.	10,97
∅ 40 x 32 mm	871 06 40	1 tk.	20 tk.	18,23
∅ 50 x 40 mm	871 06 50	1 tk.	8 tk.	29,92

Z	L	d	d1
14,0 mm	72,0 mm	20 mm	16 mm
14,0 mm	75,0 mm	25 mm	16 mm
14,0 mm	80,0 mm	25 mm	20 mm
26,4 mm	103,2 mm	32 mm	20 mm
26,4 mm	106,2 mm	32 mm	25 mm
27,7 mm	120,3 mm	40 mm	32 mm
27,7 mm	122,3 mm	50 mm	40 mm

**P**

## Põlv 90° PPSU

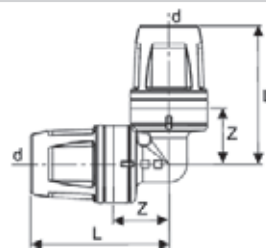

Diameeter	Tootekood	Kogus (pak. 1)	Kogus (pak. 2)	EUR/tk ilma KM
∅ 16 x 16 mm	871 07 16	10 tk.	100 tk.	3,65
∅ 20 x 20 mm	871 07 20	10 tk.	50 tk.	4,88
∅ 25 x 25 mm	871 07 25	10 tk.	40 tk.	6,77
∅ 32 x 32 mm	871 07 32	1 tk.	20 tk.	14,09
∅ 40 x 40 mm	871 07 40	1 tk.	8 tk.	25,66
∅ 50 x 50 mm	871 07 50	1 tk.	4 tk.	40,17

Z	L	d
18,5 mm	45,5 mm	16 mm
21,0 mm	53,0 mm	20 mm
23,5 mm	58,5 mm	25 mm
32,7 mm	78,0 mm	32 mm
39,4 mm	86,7 mm	40 mm
45,4 mm	92,7 mm	50 mm

**P**

## Põlv 90° PPSU (TECE liitmikku ühendatav)

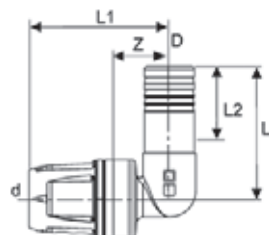

Diameeter	Tootekood	Kogus (pak. 1)	Kogus (pak. 2)	EUR/tk ilma KM
∅ 16 x 16 mm	871 11 16	10 tk.	100 tk.	4,56
∅ 20 x 20 mm	871 11 20	10 tk.	50 tk.	5,70
∅ 25 x 25 mm	871 11 25	10 tk.	40 tk.	6,95

Z	L	L1	L2	d
18,5 mm	42,6 mm	45,0 mm	26,5 mm	16 mm
21,0 mm	46,0 mm	53,0 mm	30,0 mm	20 mm
24,0 mm	51,5 mm	59,0 mm	33,0 mm	25 mm

## Põlvliitmik 90° sisekeermega

Liitmiku korpus messing

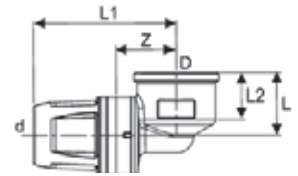

Diameeter	Tootekood	Kogus (pak. 1)	Kogus (pak. 2)	EUR/tk ilma KM	Z	L	L1	L2	D	d
∅ 16 mm x 1/2" SK	871 02 02	10 tk.	100 tk.	3,85	21,0 mm	20,0 mm	47,5 mm	15,0	1/2" SK	16
∅ 20 mm x 1/2" SK	871 02 03	10 tk.	100 tk.	5,63	21,0 mm	20,0 mm	52,5 mm	15,0	1/2" SK	20
∅ 20 mm x 3/4" SK	871 02 04	10 tk.	80 tk.	6,59	21,0 mm	22,5 mm	58,5 mm	16,3	3/4" SK	20
∅ 25 mm x 3/4" SK	871 02 05	10 tk.	50 tk.	8,99	24,0 mm	30,0 mm	58,5 mm	16,3	3/4" SK	25
∅ 32 mm x 1" SK	871 02 06	1 tk.	20 tk.	17,69	33,9 mm	35,0 mm	79,2 mm	19,1	1" SK	32

## Põlvliitmik 90° väliskeermega

Liitmiku korpus messing

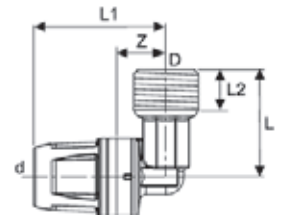

Diameeter	Tootekood	Kogus (pak. 1)	Kogus (pak. 2)	EUR/tk ilma KM	Z	L	L1	L2	D	d
∅ 16 mm x 1/2" VK	871 03 02	10 tk.	100 tk.	3,85	12,0 mm	35,0 mm	44,0 mm	13,0	1/2" VK	16
∅ 20 mm x 1/2" VK	871 03 03	10 tk.	80 tk.	6,29	12,0 mm	35,0 mm	49,0 mm	13,0	1/2" VK	20
∅ 20 mm x 3/4" VK	871 03 04	10 tk.	80 tk.	6,59	15,0 mm	36,0 mm	52,0 mm	14,0	3/4" VK	20
∅ 25 mm x 3/4" VK	871 03 05	10 tk.	50 tk.	8,39	15,0 mm	41,0 mm	55,0 mm	14,0	3/4" VK	25
∅ 25 mm x 1" VK	871 03 06	10 tk.	50 tk.	11,69	18,5 mm	44,5 mm	59,0 mm	16,8	1" VK	25
∅ 32 mm x 1" VK	871 03 12	1 tk.	20 tk.	15,89	27,9 mm	44,5 mm	73,2 mm	16,8	1" VK	32

## Otsakork

Liitmiku korpus messing

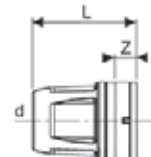

Diameeter	Tootekood	Kogus (pak. 1)	Kogus (pak. 2)	EUR/tk ilma KM	L	d
∅ 16 mm	871 08 16	10 tk.	50 tk.	3,05	34,0 mm	16 mm
∅ 20 mm	871 08 20	10 tk.	50 tk.	4,66	39,0 mm	20 mm

## Kolmik sisekeermega

Liitmiku korpus messing

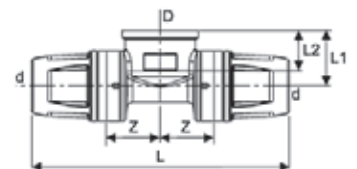

Diameeter	Tootekood	Kogus (pak. 1)	Kogus (pak. 2)	EUR/tk ilma KM	Z	L	L1	L2	D	d
∅ 16 mm x 1/2" SK x 16 mm	871 04 02	10 tk.	80 tk.	7,52	16,0 mm	95,0 mm	20,0 mm	15,0	1/2" SK	16
∅ 20 mm x 1/2" SK x 20 mm	871 04 03	10 tk.	50 tk.	9,44	16,0 mm	105,0 mm	20,0 mm	15,0	1/2" SK	20
∅ 25 mm x 3/4" SK x 25 mm	871 04 04	10 tk.	40 tk.	13,10	19,0 mm	117,0 mm	30,0 mm	16,3	3/4" SK	25
∅ 32 mm x 1" SK x 32 mm	871 04 06	1 tk.	8 tk.	21,97	34,4 mm	159,4 mm	32,0 mm	19,1	1" SK	32
∅ 40 mm x 1" SK x 40 mm	871 04 08	1 tk.	8 tk.	59,92	34,4 mm	163,4 mm	32,8 mm	19,1	1" SK	40
∅ 50 mm x 1 1/4" SK x 50 mm	871 04 10	1 tk.	4 tk.	78,84	39,4 mm	173,4 mm	39,2 mm	21,4	1 1/4" SK	50

# TECElogo – liitmikud

## Kolmik PPSU

Diameeter	Toote- kood	Kogus (pak. 1)	Kogus (pak. 2)	EUR/tk ilma KM
∅ 16 x 16 x 16 mm	871 09 16	10 tk.	40 tk.	4,69
∅ 20 x 20 x 20 mm	871 09 20	10 tk.	40 tk.	7,34
∅ 25 x 25 x 25 mm	871 09 25	10 tk.	40 tk.	10,42
∅ 32 x 32 x 32 mm	871 09 32	1 tk.	8 tk.	19,03
∅ 40 x 40 x 40 mm	871 09 40	1 tk.	8 tk.	36,57
∅ 50 x 50 x 50 mm	871 09 50	1 tk.	4 tk.	62,65

P

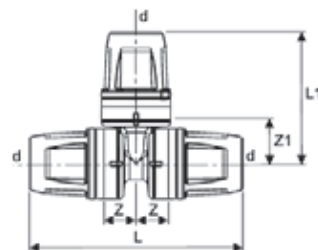

Z	Z1	L	L1	d
7,0 mm	16,0 mm	79,0 mm	48,0 mm	16 mm
9,0 mm	20,0 mm	91,0 mm	57,0 mm	20 mm
11,0 mm	23,0 mm	102,0 mm	63,0 mm	25 mm
25,4 mm	37,4 mm	141,3 mm	82,7 mm	32 mm
29,4 mm	43,4 mm	153,3 mm	90,7 mm	40 mm
33,9 mm	49,9 mm	162,4 mm	97,2 mm	50 mm

## Kolmik üleminekuuga PPSU

Diameeter	Tootekood	Kogus (pak. 1)	Kogus (pak. 2)	EUR/tk ilma KM
∅ 20 x 16 x 16 mm	871 10 04	10 tk.	40 tk.	6,28
∅ 20 x 16 x 20 mm	871 10 05	10 tk.	40 tk.	6,28
∅ 20 x 20 x 16 mm	871 10 06	10 tk.	40 tk.	6,28
∅ 25 x 16 x 16 mm	871 10 07	10 tk.	40 tk.	7,54
∅ 25 x 16 x 25 mm	871 10 08	10 tk.	40 tk.	9,89
∅ 25 x 20 x 20 mm	871 10 09	10 tk.	40 tk.	9,89
∅ 25 x 20 x 25 mm	871 10 10	10 tk.	40 tk.	10,49
∅ 20 x 25 x 20 mm	871 10 11	10 tk.	40 tk.	9,89
∅ 32 x 16 x 32 mm	871 10 12	1 tk.	8 tk.	15,23
∅ 32 x 20 x 32 mm	871 10 13	1 tk.	8 tk.	15,74
∅ 32 x 25 x 32 mm	871 10 14	1 tk.	8 tk.	16,49
∅ 32 x 25 x 25 mm	871 10 15	1 tk.	8 tk.	13,49
∅ 40 x 25 x 40 mm	871 10 17	1 tk.	8 tk.	31,17
∅ 40 x 32 x 40 mm	871 10 18	1 tk.	8 tk.	31,17
∅ 40 x 32 x 32 mm	871 10 19	1 tk.	8 tk.	31,17
∅ 50 x 25 x 50 mm	871 10 20	1 tk.	4 tk.	40,17
∅ 50 x 32 x 50 mm	871 10 21	1 tk.	4 tk.	43,16

P

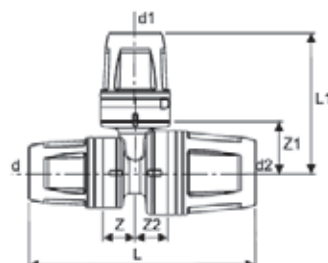
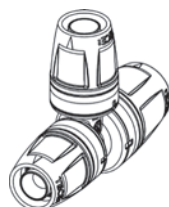

Z	Z1	Z2	L	L1	d	d1	d2
7,0 mm	19,0 mm	7,0 mm	84,0 mm	51,0 mm	20 mm	16 mm	16 mm
7,0 mm	19,0 mm	7,0 mm	89,0 mm	51,0 mm	20 mm	16 mm	20 mm
9,0 mm	20,0 mm	9,0 mm	86,0 mm	57,0 mm	20 mm	20 mm	16 mm
7,0 mm	22,0 mm	7,0 mm	87,0 mm	54,0 mm	25 mm	16 mm	16 mm
7,0 mm	22,0 mm	7,0 mm	95,0 mm	54,0 mm	25 mm	16 mm	25 mm
9,0 mm	23,0 mm	9,0 mm	89,0 mm	60,0 mm	25 mm	20 mm	20 mm
9,0 mm	23,0 mm	9,0 mm	97,0 mm	60,0 mm	25 mm	20 mm	25 mm
11,0 mm	20,0 mm	11,0 mm	96,0 mm	60,0 mm	20 mm	25 mm	20 mm
20,4 mm	34,0 mm	20,4 mm	131,3 mm	60,5 mm	32 mm	16 mm	32 mm
21,6 mm	32,5 mm	21,6 mm	133,8 mm	64,0 mm	32 mm	20 mm	32 mm
24,1 mm	32,5 mm	24,1 mm	138,8 mm	67,0 mm	32 mm	25 mm	32 mm
24,4 mm	32,5 mm	22,0 mm	126,2 mm	67,0 mm	32 mm	25 mm	25 mm
24,4 mm	38,5 mm	24,4 mm	143,3 mm	73,0 mm	40 mm	25 mm	40 mm
25,9 mm	43,4 mm	25,9 mm	146,3 mm	88,7 mm	40 mm	32 mm	40 mm
25,9 mm	43,4 mm	26,4 mm	144,8 mm	88,7 mm	40 mm	32 mm	32 mm
24,4 mm	44,6 mm	24,4 mm	143,4 mm	79,1 mm	50 mm	25 mm	50 mm
25,9 mm	49,4 mm	25,9 mm	146,4 mm	94,7 mm	50 mm	32 mm	50 mm

## Otsakork õhutusega

Liitmiku korpus messing



Diameeter	Tootekood	Kogus (pak. 1)	Kogus (pak. 2)	EUR/tk ilma KM
∅ 16 mm	874 00 01	10 tk.	50 tk.	6,89

**Kollektorliitmikud**

Liitmiku korpus messing

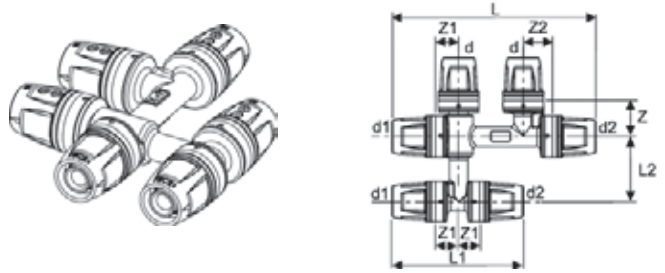

Diameeter	Tootekood	Kogus (pak. 1)	Kogus (pak. 2)	EUR/tk ilma KM	Z	Z1	Z2	L	L1	L2	d	d1	d2
∅ 16 x 16 x 16 mm	874 01 01	1 tk.	10 tk.	32,67	23,0 mm	15,0 mm	15,0 mm	128,0 mm	83,0 mm	45,0 mm	16	16	16
∅ 16 x 16 x 16 mm	874 01 02	1 tk.	10 tk.	36,87	23,0 mm	20,0 mm	15,0 mm	133,0 mm	88,0 mm	45,0 mm	16	20	16
∅ 16 x 16 x 16 mm	874 01 03	1 tk.	10 tk.	38,97	24,0 mm	20,0 mm	15,0 mm	138,0 mm	93,0 mm	45,0 mm	16	20	20

**Kollektorliitmike kaitsekarp**

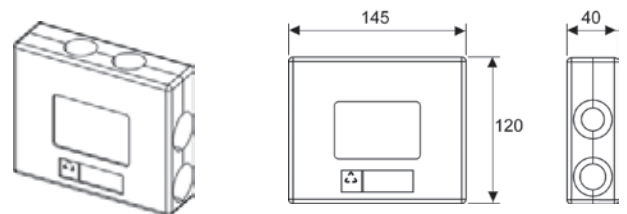

Diameeter	Tootekood	Kogus (pak. 1)	Kogus (pak. 2)	EUR/tk ilma KM
∅ 16 - 20 mm	874 01 00	1 tk.	--	4,78

**TECElogo – seinaliitmikud**

**Seinakand 90° sisekeermega**

Liitmiku korpus messing

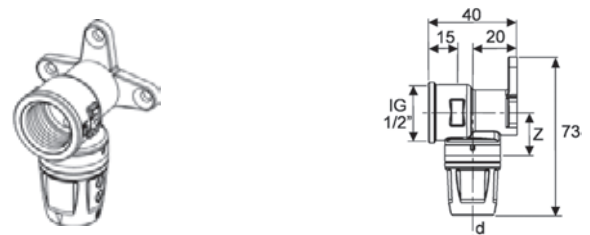

Diameeter	Tootekood	Kogus (pak. 1)	Kogus (pak. 2)	EUR/tk ilma KM	Z
∅ 16 mm x 1/2" SK	872 00 02	10 tk.	80 tk.	4,89	21,0 mm
∅ 20 mm x 1/2" SK	872 00 03	10 tk.	60 tk.	7,49	21,0 mm

**Heliisolatsiooni element**



	Tootekood	Kogus (pak. 1)	Kogus (pak. 2)	EUR/tk ilma KM
1/2" seinakannale	7 180 17	10 tk.	40 tk.	4,94

# TECElogo – seinaliitmikud

## Seinakand läbijooksuga 90° sisekeermega

Liitmiku korpus messing

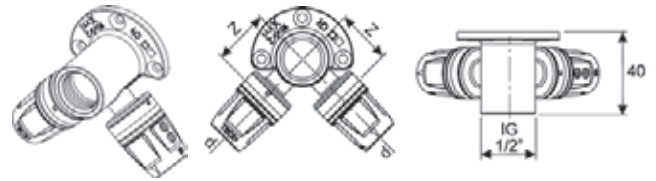

Diameeter	Tootekood	Kogus (pak. 1)	Kogus (pak. 2)	EUR/tk ilma KM	Z
ø 16 mm x 1/2" x 16 mm	872 00 07	10 tk.	40 tk.	11,09	21,0 mm

## Seinakand pikendusega 90° sisekeermega

Liitmiku korpus messing

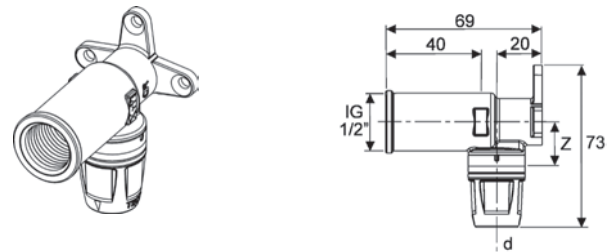

Diameeter	Tootekood	Kogus (pak. 1)	Kogus (pak. 2)	EUR/tk ilma KM	Z
ø 16 mm x 1/2" SK	872 00 08	10 tk.	50 tk.	7,34	21,0 mm

## Seinasisene läbiviigupõlv 90° sisekeermega

Liitmiku korpus messing

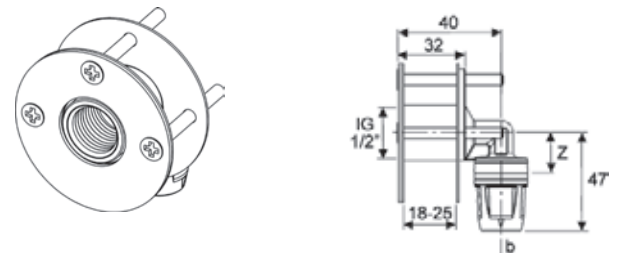

Diameeter	Tootekood	Kogus (pak. 1)	Kogus (pak. 2)	EUR/tk ilma KM	Z
ø 16 mm x 1/2" SK	872 00 09	10 tk.	40 tk.	10,76	21,0 mm



## Kinnitusplaadil seinakannad heliisolatsiooniga

- 2 heliisolatsiooni elementi
- 2 seinakanda

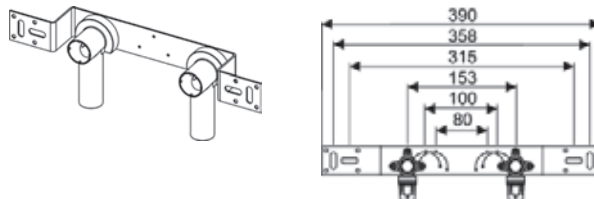

Diameeter	Tootekood	Kogus (pak. 1)	Kogus (pak. 2)	EUR/tk ilma KM
ø 16 mm x 1/2" SK	872 01 00	1 tk.	5 tk.	18,08

## Kinnitusplaadil seinakannad heliisolatsiooni ja äravoolupõlve hoidikuga

- 2 heliisolatsiooni elementi
- 2 seinakanda
- äravoolupõlve hoidik

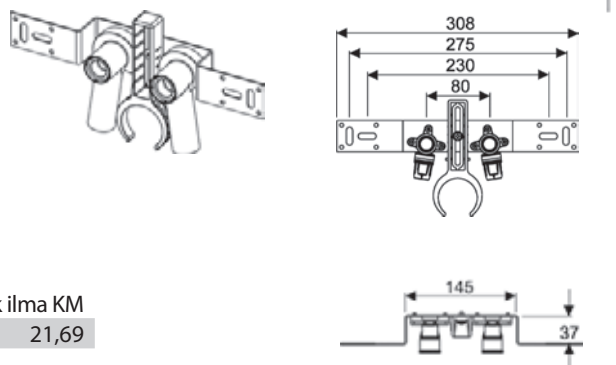

Diameeter	Tootekood	Kogus (pak. 1)	Kogus (pak. 2)	EUR/tk ilma KM
ø 16 mm x 1/2" SK	872 01 01	1 tk.	5 tk.	21,69

## TECElogo – kollektorid

Kollektorid on lihtsalt pikendatavad,  
Näiteks: 2 haruga kollektor + 3 haruga kollektor = 5 haruga kollektor

### Kaheharuline kollektor

Kollektori korpus messing, otsad 3/4" SK/VK.  
Õhutusklaapi keere 3/8" .

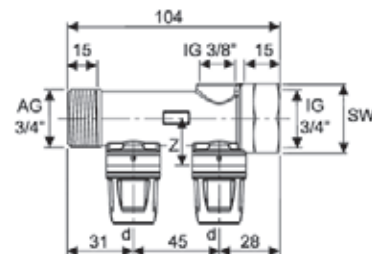

Diameeter	Tootekood	Kogus (pak. 1)	Kogus (pak. 2)	EUR/tk ilma KM
ø 16 mm kollektor	873 00 02	1 tk.	20 tk.	14,67

Z	d	SW
24,0 mm	16 mm	32

### Kolmeharuline kollektor

Kollektori korpus messing, otsad 3/4" SK/VK.  
Õhutusklaapi keere 3/8" .

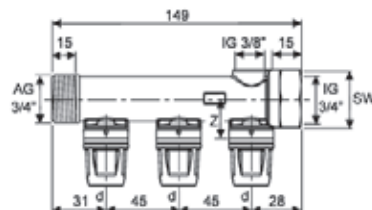
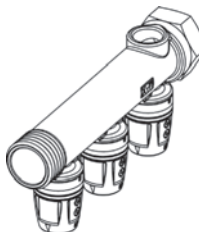

Diameeter	Tootekood	Kogus (pak. 1)	Kogus (pak. 2)	EUR/tk ilma KM
ø 16 mm kollektor	873 00 03	1 tk.	20 tk.	21,02

Z	d	SW
24,0 mm	16 mm	32

# TECElogo – adapterid

## TECElogo üleminek vasele

Liitmiku korpus messing

Diameeter	Tootekood	Kogus (pak. 1)	Kogus (pak. 2)	EUR/tk ilma KM
∅ 16 mm /15 mm Cu	873 01 00	10 tk.	100 tk.	5,66
∅ 20 mm /18 mm Cu	873 01 01	10 tk.	100 tk.	8,48
∅ 25 mm /22 mm Cu	873 01 02	10 tk.	50 tk.	9,29

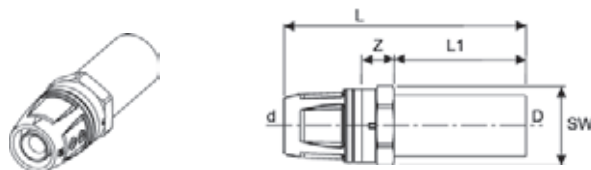

Z	L	L1	d	SW
8,0 mm	65,0 mm	25,0 mm	16 mm	25 mm
8,0 mm	70,0 mm	25,0 mm	20 mm	30 mm
8,0 mm	73,0 mm	25,0 mm	25 mm	35 mm

## TECElogo ühendusliitmik vabamutriga (amerikanka)

Liitmiku korpus messing

Diameeter	Tootekood	Kogus (pak. 1)	Kogus (pak. 2)	EUR/tk ilma KM
∅ 16 mm x 1/2"	873 02 01	5 tk.	80 tk.	10,64
∅ 16 mm x 3/4"	873 02 02	5 tk.	80 tk.	9,89
∅ 20 mm x 3/4"	873 02 03	5 tk.	50 tk.	10,79
∅ 25 mm x 1"	873 02 04	5 tk.	50 tk.	16,78
∅ 32 mm x 1 1/4"	873 02 05	1 tk.	20 tk.	19,36
∅ 32 mm x 1 1/2"	873 02 06	1 tk.	20 tk.	27,28
∅ 40 mm x 1 1/2"	873 02 07	1 tk.	20 tk.	30,58
∅ 50 mm x 1 3/4"	873 02 09	1 tk.	8 tk.	44,02

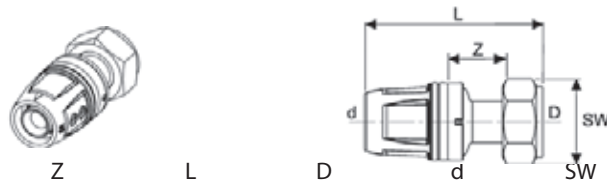

Z	L	D	d	SW
24,0 mm	50,0 mm	1/2" SK	16 mm	25 mm
24,0 mm	50,0 mm	3/4" SK	16 mm	25 mm
24,0 mm	55,0 mm	3/4" SK	20 mm	30 mm
29,0 mm	63,0 mm	1" SK	25 mm	35 mm
31,4 mm	76,7 mm	1 1/4" SK	32 mm	46 mm
35,9 mm	81,3 mm	1 1/2" SK	32 mm	52 mm
35,9 mm	83,3 mm	1 1/2" SK	40 mm	52 mm
35,9 mm	83,3 mm	1 3/4" SK	50 mm	59 mm

## TECElogo üleminek vasele (pealesurutav)

Liitmiku korpus messing

Diameeter	Tootekood	Kogus (pak. 1)	Kogus (pak. 2)	EUR/tk ilma KM
∅ 16 mm x 15 mm	871 12 02	10 tk.	80 tk.	11,21
∅ 16 mm x 18 mm	871 12 03	10 tk.	80 tk.	11,21
∅ 20 mm x 15 mm	871 12 04	10 tk.	80 tk.	11,63
∅ 20 mm x 18 mm	871 12 05	10 tk.	80 tk.	11,63

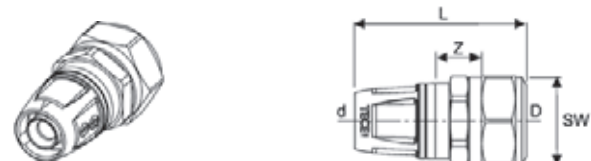

Z	L	D	d	SW
9,0 mm	60,0 mm	15 mm	16 mm	27 mm
9,0 mm	60,0 mm	18 mm	16 mm	27 mm
5,0 mm	65,0 mm	15 mm	20 mm	27 mm
5,0 mm	65,0 mm	18 mm	20 mm	27 mm

## Üleminek TECElogo torult TECEflex torule

Liitmiku korpus messing

Diameeter	Tootekood	Kogus (pak. 1)	Kogus (pak. 2)	EUR/tk ilma KM
∅ 16 mm/16 mm	873 03 00	10 tk.	80 tk.	9,32
∅ 20 mm/20 mm	873 03 01	10 tk.	80 tk.	10,01
∅ 25 mm/25 mm	873 03 02	10 tk.	80 tk.	11,66

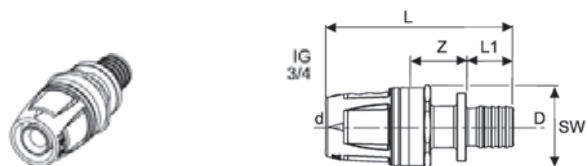

Z	L	L1	d	D	SW
19,0 mm	61 mm	15,5 mm	16 mm	16 mm	25 mm
19,0 mm	68 mm	17,5 mm	20 mm	20 mm	30 mm
20,0 mm	79 mm	24,5 mm	25 mm	25 mm	35 mm

## SLQ Eurokoonus 3/4" SK

Nikeldatud 3/4" sisekeermega eurokoonus SLQ kollektorite ühendamiseks TECElogo torudega.



Diameeter	Tootekood	Kogus (pak. 1)	Kogus (pak. 2)	EUR/tk ilma KM
∅ 16	7721 16 00	10 tk.	200 tk.	2,19
∅ 18	7721 18 00	10 tk.	200 tk.	2,19
∅ 20	7721 20 00	10 tk.	200 tk.	2,19

d	SW
16	27 mm
14	27 mm
20	27 mm

## 15 mm radiaatori põlvliitmik, nikeldatud

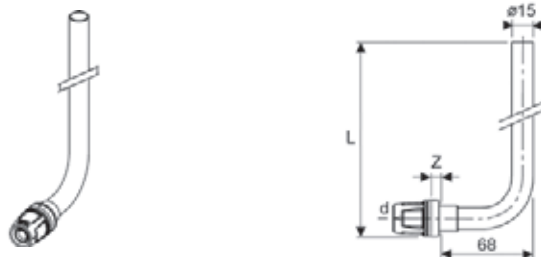

Diameeter	Tootekood	Kogus (pak. 1)	Kogus (pak. 2)	EUR/tk ilma KM	Z	L	d
∅ 16 mm/330 mm	874 04 01	10 tk.	50 tk.	10,49	3,0 mm	330,0 mm	16 mm
∅ 20 mm/330 mm	874 04 02	10 tk.	50 tk.	13,82	3,0 mm	330,0 mm	20 mm

## 15 mm radiaatori kolmikliitmik, nikeldatud

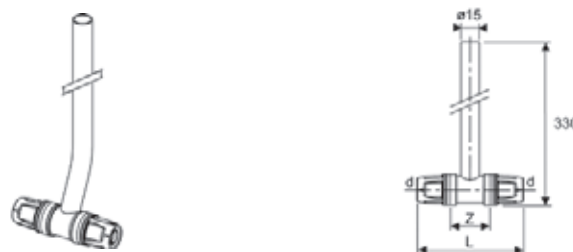

Diameeter	Tootekood	Kogus (pak. 1)	Kogus (pak. 2)	EUR/tk ilma KM	Z	d
∅ 16 mm/330 mm	874 04 03	10 tk.	40 tk.	15,68	33,0 mm	16 mm
∅ 20 mm/330 mm	874 04 04	10 tk.	40 tk.	24,58	33,0 mm	20 mm

## Radiaatori põlvliitmik

Mitmekihiline toru kaetud isolatsiooniga  
RS 9 mm, λR 0,040 W/(mK)

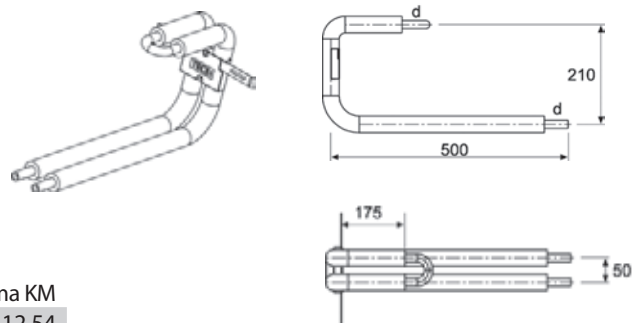

Diameeter	Tootekood	Kogus (pak. 1)	Kogus (pak. 2)	EUR/tk ilma KM
∅ 16 mm	874 05 50	1 tk.	5 tk.	12,54

## Radiaatori põlvliitmik

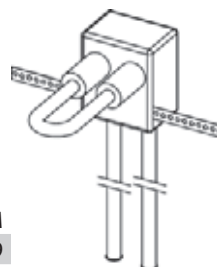

Diameeter	Tootekood	Kogus (pak. 1)	Kogus (pak. 2)	EUR/tk ilma KM
∅ 16 mm	874 05 70	1 tk.	5 tk.	16,49

# TECElogo – radiaatorite ühendustarvikud

**Radiaatori põvliitmik pöranda külge kinnitamiseks, nikeldatud**

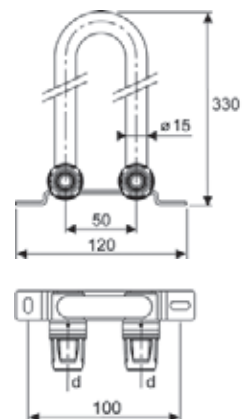
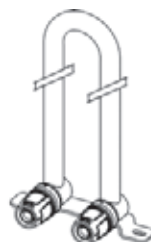

Diameeter	Tootekood	Kogus (pak. 1)	Kogus (pak. 2)	EUR/tk ilma KM
ø 16 mm/330 mm	874 04 05	1 tk.	5 tk.	26,11

**Kinnitustarvik VK tüüpi radiaatoritele, seinale külge paigaldamiseks, nikeldatud**

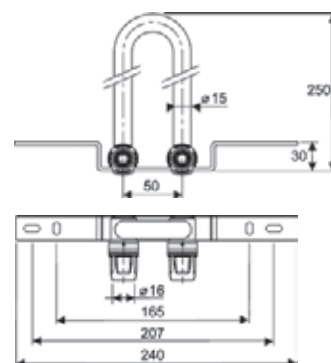
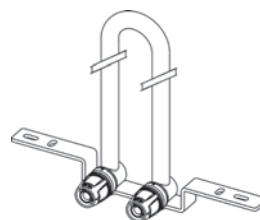

Diameeter	Tootekood	Kogus (pak. 1)	Kogus (pak. 2)	EUR/tk ilma KM
ø 16 mm/250 mm	874 04 06	1 tk.	5 tk.	24,91

**Tarvikukomplekt VK tüüpi radiaatorite ühendamiseks**

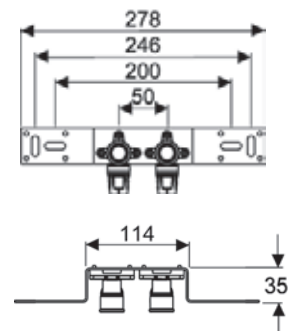
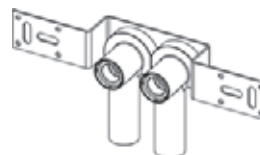

Diameeter	Tootekood	Kogus (pak. 1)	Kogus (pak. 2)	EUR/tk ilma KM
ø 16 mm	874 04 07	1 tk.	5 tk.	15,93

**Qutech tüüpi keermesühendus koostepõlvede ja kolmikute ühendamiseks radiaatorite külge**

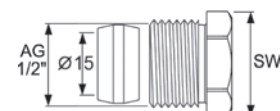

Diameeter	Tootekood	Kogus (pak. 1)	Kogus (pak. 2)	EUR/tk ilma KM
ø 15 mm x 1/2" VK	7 175 01	10 tk.	150 tk.	2,32

## Põrandaliistusteemi põvliitmik

15 mm nikeldatud vasest TECElogo süsteemile

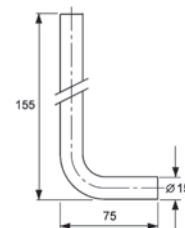

Diameeter	Tootekood	Kogus (pak. 1)	Kogus (pak. 2)	EUR/tk ilma KM
ø 15 mm	7 300 25	1 kompl (2 tk.)	20 kompl.	8,83

## Reguleeritava ventiiliga põvliitmik põrandaliistusteemile

15 mm nikeldatud vasest reguleeritava ventiiliga TECElogo süsteemile

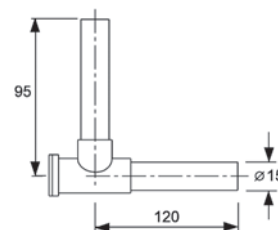
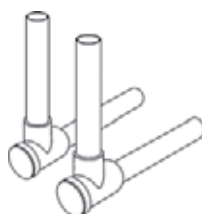

Diameeter	Tootekood	Kogus (pak. 1)	Kogus (pak. 2)	EUR/tk ilma KM
ø 15 mm	7 300 10	1 kompl (2 tk.)	20 kompl.	26,39

## TECElogo – radiaatorite ühendussõlmed

### Nikeldatud vasest radiaatori ühendus TECElogo torusüsteemile

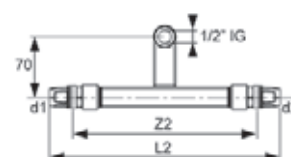
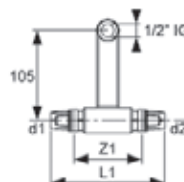

Diameeter	Tootekood	Kogus (pak. 1)	Kogus (pak. 2)	EUR/tk ilma KM	Z1	Z2	L1	L2	d1	d2
ø 16 mm x 15 Cu x ø 16 mm	874 04 21	1 kompl. (2 tk.)	10 kompl.	74,38	81,0 mm	218,0	134,0 mm	271,0 mm	16	16
ø 20 mm x 15 Cu x ø 20 mm	874 04 22	1 kompl. (2 tk.)	10 kompl.	74,38	81,0 mm	218,0	144,0 mm	281,0 mm	20	20
ø 16 mm x 15 Cu x kork	874 04 23	1 kompl. (2 tk.)	10 kompl.	74,38	--	--	104,0 mm	241,0 mm	16	kork
ø kork x 15 Cu x ø 16 mm	874 04 24	1 kompl. (2 tk.)	10 kompl.	74,38	--	--	104,0 mm	241,0 mm	kork	16

# TECElogo – tööriistad

## Toru lahtirullimisalus

Kokkupandav, reguleeritav, toru rullile kuni 600m.

Diameeter	Tootekood	Kogus (pak. 1)	Kogus (pak. 2)	EUR/tk ilma KM
kuni 600 m	7 201 93	1 tk.	--	231,70



## Toru sirgendamise seade

Diameeter	Tootekood	Kogus (pak. 1)	Kogus (pak. 2)	EUR/tk ilma KM
ø 16 - 25 mm	7 201 94	1 tk.	--	202,73

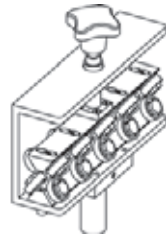

## Tööriistakomplekt:

### Torulõikur

#### Kalibreerimise tööriist

#### Võtmed demontaažiks

Diameeter	Tootekood	Kogus (pak. 1)	Kogus (pak. 2)	EUR/tk ilma KM
ø 16–25 mm	876 00 01	1 tk.	--	147,71
ø 32–50 mm	876 00 07	1 tk.	--	224,90



## TECE torukäärid, kõikidele torusüsteemidele

Diameeter	Tootekood	Kogus (pak. 1)	Kogus (pak. 2)	EUR/tk ilma KM
ø 16–25 mm	876 00 02	1 tk.	--	31,86
Varutera	876 00 03	1 tk.	--	11,30



## Torulõikur

Diameeter	Tootekood	Kogus (pak. 1)	Kogus (pak. 2)	EUR/tk ilma KM
14–63	876 00 08	1 tk.	--	72,41
Varutera	876 00 09	1 tk.	--	11,58



## Toruhoidmistangid

Diameeter	Tootekood	Kogus (pak. 1)	Kogus (pak. 2)	EUR/tk ilma KM
ø 16–25 mm	876 00 06	1 tk.	--	37,65



## Kalibreerimisotsikud

Diameeter	Tootekood	Kogus (pak. 1)	Kogus (pak. 2)	EUR/tk ilma KM
ø 16 mm	876 00 16	1 tk.	--	20,11
ø 20 mm	876 00 20	1 tk.	--	21,57
ø 25 mm	876 00 25	1 tk.	--	23,91
ø 32 mm	876 00 32	1 tk.	--	30,12
ø 40 mm	876 00 40	1 tk.	--	41,71
ø 50 mm	876 00 50	1 tk.	--	50,10



**Kalibreerimisotsiku käepide**

Diameeter	Tootekood	Kogus (pak. 1)	Kogus (pak. 2)	EUR/tk ilma KM
∅ 16–50 mm	876 00 00	1 tk.	--	18,97

**Pikendus kalibreerimisotsikutele**

Kasutamiseks akukruvikeerajatel ja drellidel

Diameeter	Tootekood	Kogus (pak. 1)	Kogus (pak. 2)	EUR/tk ilma KM
∅ 16–50 mm	876 00 05	1 tk.	--	18,97

**Demontaaži võtmed**

Diameeter	Tootekood	Kogus (pak. 1)	Kogus (pak. 2)	EUR/tk ilma KM
∅ 16–25 mm	876 01 00	1 kompl.	--	4,66
∅ 32–50 mm	876 01 01	1 kompl.	--	19,11

**Demontaaži hargid**

Diameeter	Tootekood	Kogus (pak. 1)	Kogus (pak. 2)	EUR/tk ilma KM
∅ 16–25 mm	876 04 00	1 kompl.	--	9,35
∅ 32–50 mm	876 04 02	1 kompl.	--	19,11

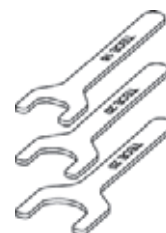
**Toru painutusvarras (sise)**

Diameeter	Tootekood	Kogus (pak. 1)	Kogus (pak. 2)	EUR/tk ilma KM
∅ 16 mm	876 02 16	1 tk.	--	8,83
∅ 20 mm	876 02 20	1 tk.	--	10,57

**Toru painutusvarras (välis)**

Diameeter	Tootekood	Kogus (pak. 1)	Kogus (pak. 2)	EUR/tk ilma KM
∅ 16 mm	876 03 16	1 tk.	--	9,12
∅ 20 mm	876 03 20	1 tk.	--	9,99

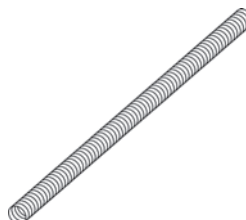
**Varuosade komplektid**

Diameeter	Tootekood	Kogus (pak. 1)	Kogus (pak. 2)	EUR/tk ilma KM
∅ 16 mm	879 00 16	1 kompl.	--	1,57
∅ 20 mm	879 00 20	1 kompl.	--	2,09
∅ 25 mm	879 00 25	1 kompl.	--	2,69
∅ 32 mm	879 00 32	1 kompl.	--	5,79
∅ 40 mm	879 00 40	1 kompl.	--	11,25
∅ 50 mm	879 00 50	1 kompl.	--	17,27



# TECE – projekteerimistarkvara

**Komplektne tarkvara InstalSystem-TECE Baltikum on mõeldud projekteerijatele, disaineritele aga ka hooldusteenuse pakkujatele.**

Pakett sisaldab:

- Õppematerjalid.
- Küttesüsteemide projekteerimise osa Instal-therm.
- Soojakadude arvutamise programm Instal-heat&energy.
- Sanitaartechnilise disaini osa Instal-san.

## Programmide eesmärk ja võimalused

### Instal – therm

See on põranda- ja seinakütte ning radiaatorkütte (ühe toru, kahe toru ja kollektoritega) projekteerimistarkvara. Vastavalt etteantud andmetele arvutatakse hüdrostsüsteem, valitakse automaatselt toru mõõdud ja radiaatorid, ventiilid jne. Tulemuseks on valmis projekt, koos täieliku kirjelduse ja spetsifikatsiooniga.

### Instal-heat&energy

Programm **Instal-heat&energy** on tihedalt seotud programmiga **InstalSystem-TECE Baltikum**. Seda kasutatakse soojuskao arvutusteks projekteeritud või ehitatud hoonetes. Madalaim temperatuur valitakse vastavalt Eesti ilmajaamadele.

Valmis joonised on ühised mõlemas programmis (**Instal-heat&energy ja Instal-therm**). Soojuskao arvutamiseks **Instal-heat&energy** programmi abil ja tulemused salvestatakse faili, mida saab seejärel kasutada radiaator – ja põrandakütte tehniliste parameetrite arvutamiseks.

AutoCAD programmi joonised DWG või DXF faili kujul saab importida **Instal-therm** programmi ja seejärel teha soojuskao arvutused **Instal-heat&energy** programmis. Seejärel saab joonised jälle AutoCAD programmi tagasi tõsta.

### Instal-san

Programm **Instal-san** kuuma –ja külma tarbevee süsteemide projekteerimiseks. Sisestades programmi andmed joonistab programm automaatselt torustike paigalduse skeemi. Seejärel saab teha hüdraulika ja muud süsteemielementide arvutused.

<b>Nimi</b>	300 EUR/ tk ilma KM
Instal – therm/heat&energy	175 EUR/ tk ilma KM
Instal-san	125 EUR/ tk ilma KM





TECEfloor

**TECE**floor  
Hinnakiri 2013

**TECE:**

Intelligente Haustechnik

## TECEfloor – põrandakütte valik

30 aastat tagasi hakkas TECE ühena esimestest Euroopas arendama ja müüma plasttorudel põhinevaid põrandaküttesüsteeme. Mis oli tulemuseks? Aastatel 1977-1978 alumiinium komposiitoru ja palju väga väärtuslikke partnerlusi ning kogemusi. Meie TECEfloor põrandaküttekomponeendid on näha järgnevatel lehekülgedel.

Kõiki komponente võib kombineerida TECEflex või TECElogo toodetega.



TC2000 brošüür aastat 1982.  
Teema: korrosioonikindlus.

## Kõik sobib!

See on TECEfloor põrandakütte valiku loosung. Meie eesmärgiks on kõrvaldada vead mille põhjuseks on teineteisega mitesobivad komponendid. TECE laboris on kõik komponendid omavahel testitud katsestendide ekstremaalsetes tingimustes. Ainult sel viisil on võimalik kõrvaldada projekteerimisel tekkinud vead. Näiteks, et tagada toru läbimõõdu täpsus ühendamisel kollektoriga, eurokoonuse tihendi sobivus või ajami töökindlus. Ainult komponendid mis on sobitatud teineteisega ja testitud tagavad probleemideta ühenduse.

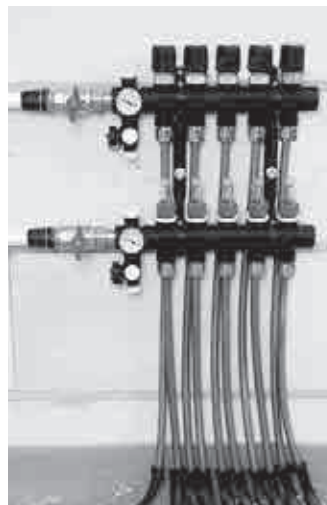

## Maksimaalne funktsionaalsus: Kombineeri kolm ühes!

TECE plastist moodulkollektorid on täpselt see mida vajate. Kahe või kolme mooduliga kollektorid saab omavahel kiiresti ühendada ja luua kuni 12 kontuuriga kollektori. Kui objektil on nõutav näiteks üks lisakontuur, saate selle ka kiirelt juurde lisada, vahetades näiteks kaheosalise mooduli kolmeosalise mooduli vastu ja probleem on lahendatud. Vaid kolme tooteartikliga saate kogu töö ära tehtud.

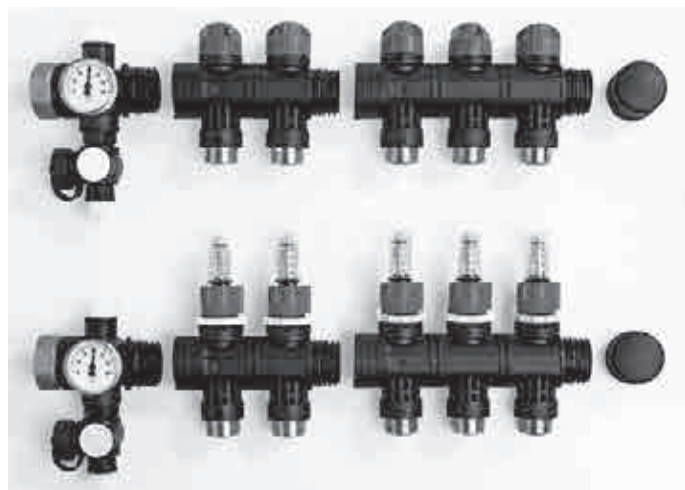



	Lehekülg
TECEfloor põrandaküttetorud	60
TECEfloor keermesühendused	62
TECEfloor täiendavad materjalid	63
TECEfloor paigaldussüsteemid	64
TECEfloor kollektorid	67
TECEfloor kollektorkapid	72
TECEfloor juhtimisautomaatika	73
TECEfloor tööriistad ja tarvikud	74
Projekteerimistarkvara	75

# TECEfloor – põrandaküttetorud

## SLQPE-RT Type 2 põrandaküttetoru

Toru on valmistatud vastavalt DIN 16833/16834 sertifikaadile, toru PE-RT Type 2 (suurem tihedus ja parem vastupidavus siserõhule).



SLQ omadused ja kvaliteet vastavad sertifikaatidele DIN 4726 ja DIN EN ISO 22391-2:

Diam. 14 x 2 Klass 4: 10 bar, Tmax 70° / Klass 5: 8 bar, Tmax 90°

Diam. 16 x 2 Klass 4: 8 bar, Tmax 70° / Klass 5: 8 bar, Tmax 90°

Diam. 17 x 2 Klass 4: 8 bar, Tmax 70° / Klass 5: 6 bar, Tmax 90°

Diam. 20 x 2 Klass 4: 6 bar, Tmax 70° / Klass 5: 6 bar, Tmax 90°

Diameeter	Tootekood	Kogus (pak. 1)	Kogus (pak. 2)	Kogus (pak. 3)	EUR/jm ilma KM
ø 14 x 2 mm	7712 14 30	300 m	1800 m	3600 m	0,85
ø 14 x 2 mm	7712 14 60	600 m	1800 m	3600 m	0,85
ø 16 x 2 mm	7712 16 30	300 m	1500 m	3000 m	0,85
ø 16 x 2 mm	7712 16 60	600 m	1200 m	2400 m	0,85
ø 17 x 2 mm	7712 17 30	300 m	1200 m	2400 m	0,85
ø 17 x 2 mm	7712 17 56	560 m	1120 m	2240 m	0,85
ø 20 x 2 mm	7712 20 30	300 m	900 m	1800 m	1,00
ø 20 x 2 mm	7712 20 60	600 m	2400 m	--	1,00

## SLQ PE-Xc põrandaküttetoru

Toru on valmistatud vastavalt DIN 16892/16893 sertifikaadile, Valmistatud kõrgtihedusega polüetüleenist, mille molekulaarstruktuuri on muudetud elektronkiire abil.



SLQ toru omadused ja kvaliteet vastavad sertifikaatidele DIN 4726 ja DIN EN ISO 15875-2:

Diam. 14 x 2 Klass 4: 10 bar, Tmax 70° / Klass 5: 10 bar, Tmax 90°

Diam. 16 x 2 Klass 4: 10 bar, Tmax 70° / Klass 5: 8 bar, Tmax 90°

Diam. 17 x 2 Klass 4: 10 bar, Tmax 70° / Klass 5: 8 bar, Tmax 90°

Diameeter	Tootekood	Kogus (pak. 1)	Kogus (pak. 2)	Kogus (pak. 3)	EUR/jm ilma KM
ø 14 x 2 mm	7713 14 30	300 m	1800 m	3600 m	1,06
ø 14 x 2 mm	7713 14 60	600 m	1800 m	3600 m	1,06
ø 16 x 2 mm	7713 16 30	300 m	1500 m	3000 m	1,09
ø 16 x 2 mm	7713 16 60	600 m	1200 m	2400 m	1,09
ø 17 x 2 mm	7713 17 30	300 m	1200 m	2400 m	1,17
ø 17 x 2 mm	7713 17 56	560 m	1120 m	2240 m	1,17

## SLQ MDXc-5S põrandaküttetoru

Toru on valmistatud vastavalt DIN 16894/16895 sertifikaadile.  
SLQ toru omadused ja kvaliteet vastavalt sertifikaatidele  
DIN 4724 ja DIN EN ISO 21003-2



Klass 4: 6 bar, Tmax 70° / Klass 5: 6 bar, Tmax 90°

Diameeter	Tootekood	Kogus (pak. 1)	Kogus (pak. 2)	Kogus (pak. 3)	EUR/jm ilma KM
ø 16 x 2 mm	7714 16 30	300 m	1500 m	3000 m	1,00
ø 16 x 2 mm	7714 16 60	600 m	1200 m	2400 m	1,00
ø 18 x 2 mm	70 33 18	200 m			1,18
ø 18 x 2 mm	70 35 18	600 m			1,18

## TECElogo PE-RT mitmekihiline toru

Paigaldusklass DIN EN ISO 15875-1:  
Küttesüsteemid: maksimaalne töötemperatuur 80 °C,  
Maksimaalne tööõhk 10 bar,  
Maksimaalne lühiajaline temperatuur 95 °C max. 100 h

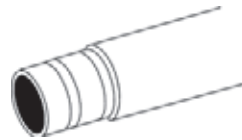

### PE-RT mitmekihiline toru

Mitmekihiline alumiiniumiga joogivee ja küttetoru,  
välimine kiht valge PE

Diameeter	Tootekood	Kogus (pak. 1)	Kogus (pak. 2)	Kogus (pak. 3)	EUR/jm ilma KM
ø 16 x 2 mm rull	870 50 16	100 m	1000 m	2000 m	1,00
ø 18 x 2 mm rull	870 50 18	200 m	700 m	1400 m	1,28
ø 20 x 2,25 mm rull	870 50 20	100 m	700 m	1400 m	1,51

# TECEfloor – keermesühendused

## SLQ Eurokoonus 3/4" SK

Nikeldatud 3/4" SK liitmik SLQ torude või TECElogo torude ühendamiseks kollektoriga.



Diameeter	Tootekood	Kogus (pak. 1)	Kogus (pak. 2)	EUR/tk ilma KM
14	7721 14 00	10 tk.	200 tk.	2,19
16	7721 16 00	10 tk.	200 tk.	2,19
17	7721 17 00	10 tk.	200 tk.	2,19
18	7721 18 00	10 tk.	200 tk.	2,19
20	7721 20 00	10 tk.	200 tk.	2,19

d	SW
14	27 mm
16	27 mm
17	27 mm
18	27 mm
20	27 mm

## SLQ otseühendus

SLQ nikeldatud otseühendus 3/4" vk.



Diameeter	Tootekood	Kogus (pak. 1)	Kogus (pak. 2)	EUR/tk ilma KM
3/4" x 3/4"	7722 00 34	10 tk.	100 tk.	2,17

d	SW
3/4"	27 mm

## SLQ remondikomplekt.

Remondikomplekt SLQ PE-Xc, SLQ MDXc, PE-MDXc torudele.



Diameeter	Tootekood	Kogus (pak. 1)	Kogus (pak. 2)	EUR/tk ilma KM
14 x 14	7722 00 14	1 tk.	10 tk.	4,05
16 x 16	7722 00 16	1 tk.	10 tk.	4,05
17 x 17	7722 00 17	1 tk.	10 tk.	10,72
20 x 20	7722 00 20	1 tk.	10 tk.	10,72

## TECE isolatsiooniplaat 35-3 DES WLG 045

Valmistatud EPS DES sg, WLG 045,  $R\lambda = 0,75 (m^2 \cdot K)/W$ , kaetud rebenemiskindla fooliumiga, maksimaalne koormus 4 kPa/m<sup>2</sup>, heliisolatsioon 29 dB

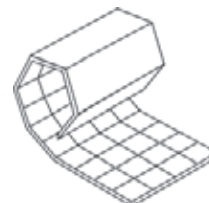

Mõõt	Tootekood	Kogus (pak. 1)	Kogus (pak. 2)	EUR/tk ilma KM /1 m <sup>2</sup>
Laius 1 m / pikkus 5 m	7753 92 00	10 m <sup>2</sup>	--	5,36

## Kleeflint

Hermeetiline kleeflint

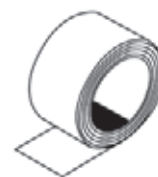

Tootekood	Kogus (pak. 1)	Kogus (pak. 2)	EUR/tk ilma KM
7760 00 10	1 tk.	--	3,91

## Kleeflindihoidja

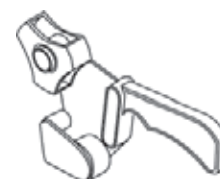

Tootekood	Kogus (pak. 1)	Kogus (pak. 2)	EUR/tk ilma KM
7760 00 20	1 tk.	--	10,37

# TECEfloor – paigaldussüsteemid

## 6mm Tacker klambrite paigaldustööriist

Diameeter	Tootekood	Kogus (pak. 1)	Kogus (pak. 2)	EUR/tk ilma KM
6 mm	7761 00 15	1 tk.	--	137,86



## Tacker klamber 6 mm, Diam. 14–20

Rõhknael toru kinnitamiseks isolatsiooniplaadi külge.

Diameeter	Tootekood	Kogus (pak. 1)	Kogus (pak. 2)	EUR/tk ilma KM
14–20	7761 00 16	300 tk.	--	0,05



## Paigaldusplaat

Spetsiaalsete hoidikutega kütetoru fikseerimiseks. Paigaldamise sammud: 6, 12, 18, 24 ja 30. Torudele läbimõõduga 14 kuni 17mm.

Diameeter	Tootekood	Kogus (pak. 1)	Kogus (pak. 2)	EUR ilma KM/1 m <sup>2</sup>
840 x 1440 mm	7751 00 30	16,8 m <sup>2</sup>	201,6 m <sup>2</sup>	8,98



## Kompensatsioonielement

Paigaldusplaatidele 77510031

Diameeter	Tootekood	Kogus (pak. 1)	Kogus (pak. 2)	EUR/ tk ilma KM
laius 900 mm	7751 00 31	10 tk.	--	14,50

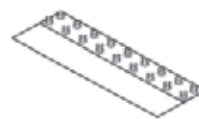



## Plastikuga kaetud sidumistraat

Tootekood	Kogus (pak. 1)	Kogus (pak. 2)	EUR ilma KM/1000 tk.
7761 10 20	1000 tk.	--	19,69



## Toruklamber

Toruklamber diameetritele 16 ja 18mm paigaldamiseks 3mm võrgule.

Mõõt	Tootekood	Kogus (pak. 1)	Kogus (pak. 2)	EUR/tk ilma KM
16–18 mm	7761 10 10	100 tk.	--	0,08



## Rõhknaelad paigaldusreli kinnitamiseks

Tootekood	Kogus (pak. 1)	Kogus (pak. 2)	EUR/tk ilma KM
7761 20 10	200 tk.	800 tk.	0,08



## Paigaldusrelss

Paigaldusrelss TECEfloor torudele diameetriga 14 kuni 20mm.

Mõõt	Tootekood	Kogus (pak. 1)	Kogus (pak. 2)	EUR/tk ilma KM
14–20 mm	7757 00 10	10 m	100 m	2,17

Ühiku pikkus pakendis = 100 cm (4 x 25 cm)



## Kompensatsioonilint perimeetrile

Valmistatud PE vahust, isekleepuv, fooliumiga.

Mõõt	Tootekood	Kogus (pak. 1)	Kogus (pak. 2)	EUR/jm ilma KM
10 x 160 mm	7762 00 10	100 m	--	0,60

Rullis 25 m



# TECEfloor – paigaldussüsteemid

## Deformatsiooniprofiil

Valmistatud PE vahust, isekleepuv, 40 mm lai.

Mõõt	Tootekood	Kogus (pak. 1)	Kogus (pak. 2)	EUR/tk ilma KM
10 x 100 mm	7763 00 10	18 m	--	5,79

Pikkus = 180 cm

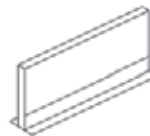

## Betooni plastifikaator

Plastifitseeriv lisaaine betoonile ja tasanduskihile.  
10kg kanistris.

Nõue: 0.03 kg/m<sup>2</sup> , betoonikihi paksus 1cm.

Kogus	Tootekood	Kogus (pak. 1)	Kogus (pak. 2)	EUR/tk ilma KM
10 kg kanister	7764 00 10	1 tk.	--	3,91



## Torutugi 90°

Valmistatud plastikust.

Mõõt	Tootekood	Kogus (pak. 1)	Kogus (pak. 2)	EUR/tk ilma KM
14–18 mm	7791 00 10	25 tk.	200 tk.	0,87
20 mm	7791 00 11	25 tk.	100 tk.	1,16



**SLQ roostevabast terasest kollektor koos vooluhulgamõõturitega**

Roostevabast terasest 1" küttekollektor koos vooluhulga mõõturite, integreeritud reguleeriventilide, 3/4" niplite, seinakinnituste, korkide, õhutusventiilide ja täitekraanidega. Pmax. 6 bar, Tmin 6 °C, Tmax 70 °C. Seinakinnituste heliisolatsioon vastavalt DIN 4109.

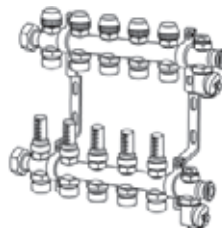

Kontuuride arv	Tootekood	Kogus (pak. 1)	Kogus (pak. 2)	EUR/tk ilma KM
2 kontuuri	7731 10 02	1 tk.	--	82,71
3 kontuuri	7731 10 03	1 tk.	--	104,13
4 kontuuri	7731 10 04	1 tk.	--	126,14
5 kontuuri	7731 10 05	1 tk.	--	148,14
6 kontuuri	7731 10 06	1 tk.	--	170,14
7 kontuuri	7731 10 07	1 tk.	--	192,15
8 kontuuri	7731 10 08	1 tk.	--	214,15
9 kontuuri	7731 10 09	1 tk.	--	236,15
10 kontuuri	7731 10 10	1 tk.	--	258,16
11 kontuuri	7731 10 11	1 tk.	--	280,16
12 kontuuri	7731 10 12	1 tk.	--	302,48

Ühendused 3/4" eurokoonustele. Ühendused tuleb pingutada peale esimest kütteperioodi.

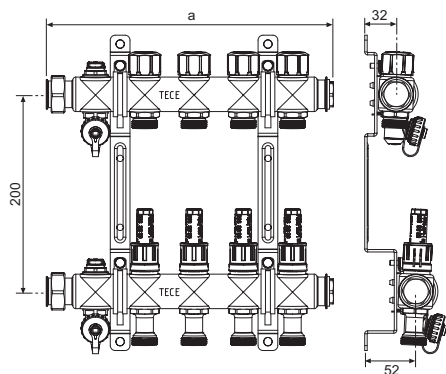

SLQ Roostevabast terasest kollektorite pikkused:

Kontuurid	Pikkus mm	Kontuurid	Pikkus mm
2	190	8	490
3	240	9	540
4	290	10	590
5	340	11	640
6	390	12	690
7	440		

# TECEfloor – kollektorid

## SLQ plastist kollektori ühenduskomplekt

Põhikomplekt millega saab ühendada kahe- või kolmekontuurseid plastkollektoreid. Komplekt sisaldab õhutusventiile ja täiteklappe, seinakinnitusi, korke ja termomeetrit. Tmax. 60 °C 6 bari juures, Tmax 90 °C 3 bari juures.

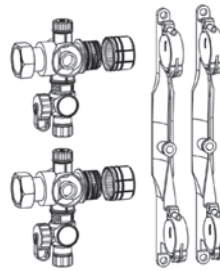

Tüüp	Tootekood	Kogus (pak. 1)	Kogus (pak. 2)	EUR/tk ilma KM
Ühenduskomplekt	7739 00 10	1 tk.	--	75,35

## SLQ plastist kokkupandav reguleeritav põrandaküttekollektor

Komplekt sisaldab vooluhulgamõõtureid, integreeritud reguleeriventiile M30x1,5mm ja 3/4" nipleid.

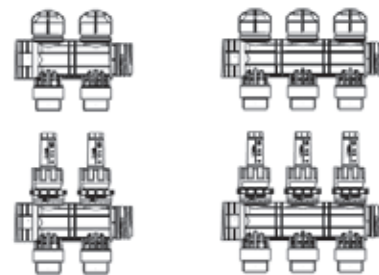

Kontuuride arv	Tootekood	Kogus (pak. 1)	Kogus (pak. 2)	EUR/tk ilma KM
2 kontuuri	7739 00 20	1 tk.	--	59,65
3 kontuuri	7739 00 30	1 tk.	--	87,91

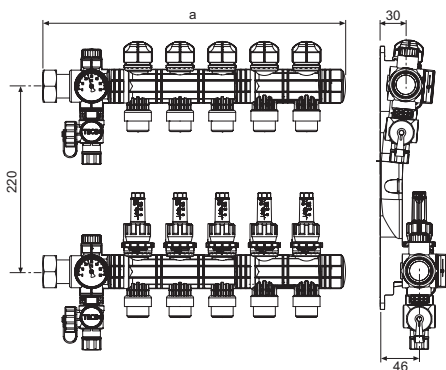

SLQ plastist põrandaküttekollektorite pikkused:

Kontuurid	Pikkus mm	Kontuurid	Pikkus mm
2	202	8	502
3	252	9	552
4	302	10	602
5	352	11	652
6	402	12	702
7	452		

**SLQ nurk kuulkraan**

SLQ nurk kuulkraani komplekt 3/4" SK/ 1" VK

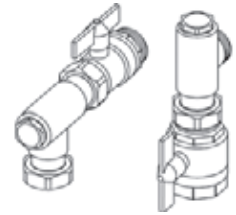

Mõõt	Tootekood	Kogus (pak. 1)	Kogus (pak. 2)	EUR/tk ilma KM
3/4" SK x 1" VK	7738 10 02	1 tk.	--	78,19

**SLQ kuulkraan termomeetriga**

Kuulkraan 1" SK/VK, nikeldatud, pöörlev termomeetriga käepide.  
Punane või sinine, pikkus 70mm



Diameeter/värv	Tootekood	Kogus (pak. 1)	Kogus (pak. 2)	EUR/tk ilma KM
1" SK x 1" VK/ punane	7738 10 04	1 tk.	16 tk.	20,09
1" SK x 1" VK/ sinine	7738 10 05	1 tk.	16 tk.	20,09

**SLQ nurk kuulkraani komplekt**

Täite/äravoolu süsteemile.

SLQ nurk kuulkraani komplekt 3/4" SK/ 1" VK

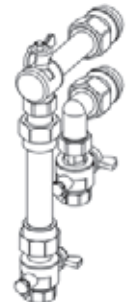

Mõõt	Tootekood	Kogus (pak. 1)	Kogus (pak. 2)	EUR/tk ilma KM
3/4" SK x 1" VK	7738 20 05	1 tk.	--	86,89

# TECEfloor – kollektorid

## SLQ plastist tööstuslike kollektorite ühendus ja paigalduskomplekt.

DN 1 ½"

Komplektis:

- Kinnitused
- Sulgventiilid
- Termomeetrid
- Äravooluventiilid

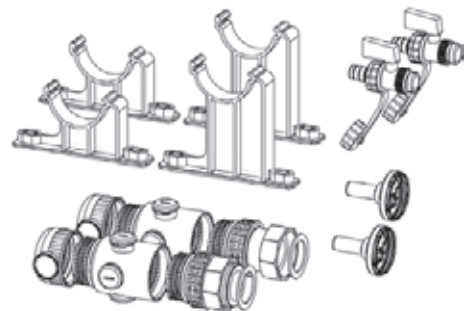

	Tootekood	Kogus (pak. 1)	Kogus (pak. 2)	EUR/tk ilma KM
Ühenduskomplekt	7739 01 10	1 tk.	--	131,90

## SLQ plastist tööstusliku kollektori osa. DN 1 ½"

Vooluhulgamõõduri mõõtmisvahemik (4-20 l/min.)

Ühendus ¾" eurokoonusele.

Tagasivoolu ajami ühendamise võimalus ja ühendus ¾" eurokoonusele.

Võimalik ühendada kuni 20 kontuuri

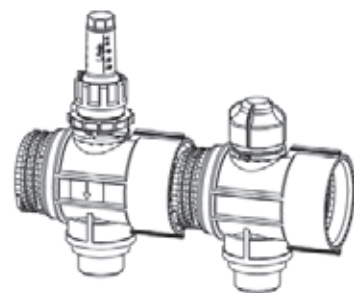

	Tootekood	Kogus (pak. 1)	Kogus (pak. 2)	EUR/tk ilma KM
Komplekt	7739 01 11	1 tk.	--	58,90

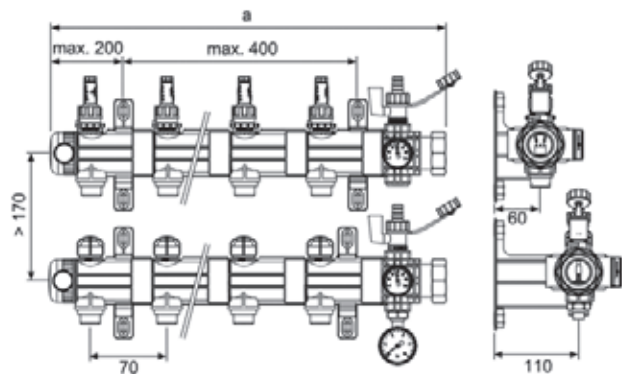

Kontuurid	Pikkus (a) mm	Kontuurid	Pikkus (a) mm
2	250	11*	880
3	320	12*	950
4	390	13*	1020
5	460	14*	1090
6	530	15*	1160
7	600	16*	1320
8	670	17*	1300
9	740	18*	1370
10	810	19*	1440
		20*	1510

\* alates 11 kontuurist kasutage lisakinnitusi. Tootekood 7739 01 20

## SLQ tööstuslike kollektorite kandurid

Nõutav kollektoritele, kui pikkus ületab 10 kontuuri

	Tootekood	Kogus (pak. 1)	Kogus (pak. 2)	EUR/tk ilma KM
Kandurid	7739 01 20	1 tk.	--	16,30

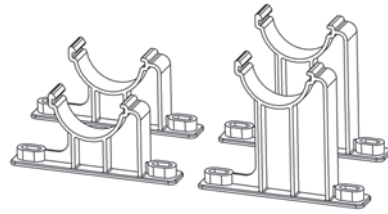

## SLQ tööstuslike kollektorite manomeeter

	Tootekood	Kogus (pak. 1)	Kogus (pak. 2)	EUR/tk ilma KM
Manomeeter	7739 01 30	1 tk.	--	16,90



## SLQ kuulkraanide komplekt DN 1 ½“ (pikk käepide)

	Tootekood	Kogus (pak. 1)	Kogus (pak. 2)	EUR/tk ilma KM
Kuulkraan	7738 10 06	1 kompl.	--	52,90



## Kollektorkapi lukk koos võtmega

	Tootekood	Kogus (pak. 1)	Kogus (pak. 2)	EUR/ tk ilma KM
Lukk	7799 00 10	1 tk.	10 tk.	9,99

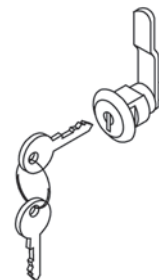

# TECEfloor – kollektorkapid

## Seinasisene kollektorkapp

Valmistatud galvaniseeritud terasest, kapikülgedel on avad, kapis sees on siinid kollektorite kinnitamiseks, eemaldatav uks, ukse ja raami värv RAL 9010, reguleeritav sügavus 110–150 mm, reguleeritav kõrgus 690–790 mm.

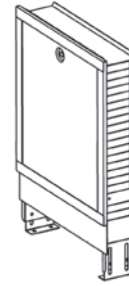

Laius	Tootekood	Kogus (pak. 1)	Kogus (pak. 2)	EUR/tk ilma KM
450 mm (2 – 4 kont.)	7735 10 21	1 tk.	--	49,24
530 mm (5 – 8 kont.)	7735 10 22	1 tk.	--	53,58
680 mm (6 – 9 kont.)	7735 10 23	1 tk.	--	60,53
830 mm (9 – 12 kont.)	7735 10 24	1 tk.	--	62,85
1030 mm (12 – 16 kont.)	7735 10 25	1 tk.	--	81,09

## Seinapealne kollektorkapp

Valmistatud galvaniseeritud terasest, värv RAL 9010, kapis sees on siinid kollektorite kinnitamiseks, sügavus 125 mm, kõrgus 640 mm

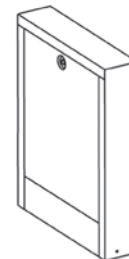

Laius	Tootekood	Kogus (pak. 1)	Kogus (pak. 2)	EUR/tk ilma KM
450 mm (2 – 4 kont.)	7736 10 21	1 tk.	--	49,24
530 mm (5 – 8 kont.)	7736 10 22	1 tk.	--	53,87
680 mm (6 – 9 kont.)	7736 10 23	1 tk.	--	62,85
830 mm (9 – 12 kont.)	7736 10 24	1 tk.	--	71,83
1030 mm (12 – 16 kont.)	7736 10 25	1 tk.	--	83,12



## 230 V TECE termostaat

Temperatuur 10 – 30° C, püsivus +0,2K, (paigaldatakse koos termostaadi hoidikuga tootekoodiga 77410011)



Diameeter	Tootekood	Kogus (pak. 1)	Kogus (pak. 2)	EUR/tk ilma KM
55 mm diam	7741 00 10	1 tk.	10 tk.	31,75

## TECE termostaadi hoidik

Paigaldatakse koos TECE termostaadiga (tootekood 77410010)



Diameeter	Tootekood	Kogus (pak. 1)	Kogus (pak. 2)	EUR/tk ilma KM
55 mm diam	7741 00 11	1 tk.	10 tk.	4,70

## SLQ ajam kollektorile 230 V

Paigaldamiseks SLQ küttekollektoritele, süsteemi kaitse IP54, paigaldatav 360° igas asendis, ühendus M 30 x 1.5 valmistatud nikeldatud messingist. Optimaalne jõud 80 N, ühendus 230 V.



Tootekood	Kogus (pak. 1)	Kogus (pak. 2)	EUR/tk ilma KM
7749 00 10	1 tk.	10 tk.	21,68

## SLQ ajam kollektorile 24 V

Paigaldamiseks SLQ küttekollektoritele, süsteemi kaitse IP54, paigaldatav 360° igas asendis, ühendus M 30 x 1.5 valmistatud nikeldatud messingist. Optimaalne jõud 80 N, ühendus 24 V



Tootekood	Kogus (pak. 1)	Kogus (pak. 2)	EUR/tk ilma KM
7749 00 20	1 tk.	10 tk.	21,68

## TECE ühenduskarp 230 V

Lihne ühendada ajameid kollektoril toatermostaatidega ja toitega, Vastavalt Saksa VDE nõuetele. Sobib maksimaalselt 6 toatermostaadile ja maksimaalselt 12 kollektori ajamile.

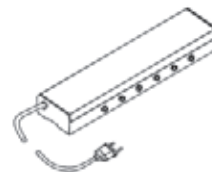

Tootekood	Kogus (pak. 1)	Kogus (pak. 2)	EUR/tk ilma KM
7743 00 10	1 tk.	--	73,46

# TECEfloor – tööriistad ja tarvikud

## Toru lahtirullimisalus

Kokkupandav, reguleeritav, toru rullile kuni 600m

	Tootekood	Kogus (pak. 1)	Kogus (pak. 2)	EUR/tk ilma KM
kuni 600 m	7 201 93	1 tk.	--	231,70

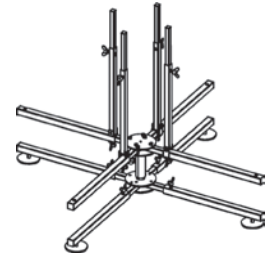

## Toru lahtirullimisalus ratastel

Torurullidele kuni 900m

	Tootekood	Kogus (pak. 1)	Kogus (pak. 2)	EUR/tk ilma KM
Ratastel alus	7792 00 20	1 tk.	--	318,00

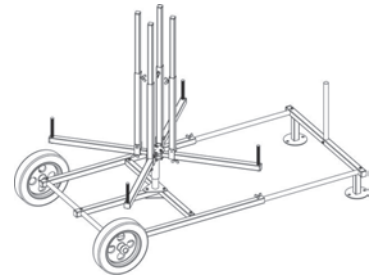

## TECE universaalsed torukäärid

Diameeter	Tootekood	Kogus (pak. 1)	Kogus (pak. 2)	EUR/tk ilma KM
14–25	876 00 02	1 tk.	--	31,86
Torukäärde varutera	876 00 03	1 tk.	--	11,30



## SLQ toru kalibraator. Torudele läbimõõduga 14/16/17/20 mm

	Tootekood	Kogus (pak. 1)	Kogus (pak. 2)	EUR/tk ilma KM
Kalibraator	7792 00 00	1 tk.	--	29,80

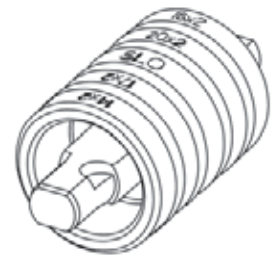

## SLQ toru laiendamise otsik. Torudele läbimõõduga 17/20 mm

Diameeter	Tootekood	Kogus (pak. 1)	Kogus (pak. 2)	EUR/tk ilma KM
17 x 2 mm	7792 17 00	1 tk.	--	57,92
20 x 2 mm	7792 20 00	1 tk.	--	57,92



**Komplektne tarkvara InstalSystem-TECE Baltikum on mõeldud projekteerijatele, disaineritele aga ka hooldusteenuse pakkujatele.**

Pakett sisaldab:

- Õppematerjalid.
- Küttesüsteemide projekteerimise osa Instal-therm.
- Soojakadude arvutamise programm Instal-heat&energy.
- Sanitaartehnilise disaini osa Instal-san.

## Programmide eesmärk ja võimalused

### Instal – therm

See on pörand- ja seinakütte ning radiaatorkütte (ühe toru, kahe toru ja kollektoritega) projekteerimistarkvara. Vastavalt etteantud andmetele arvutatakse hüdro süsteem, valitakse automaatselt toru mõõdud ja radiaatorid, ventiilid jne. Tulemuseks on valmis projekt, koos täieliku kirjelduse ja spetsifikatsiooniga.

### Instal-heat&energy

Programm **Instal-heat&energy** on tihedalt seotud programmiga **InstalSystem-TECE Baltikum**. Seda kasutatakse soojuskao arvutusteks projekteeritud või ehitatud hoonetes. Madalaim temperatuur valitakse vastavalt Eesti ilmajaamadele andmetele.

Valmis joonised on ühised mõlemas programmis (**Instal-heat&energy ja Instal-therm**). Soojuskao arvutatakse **Instal-heat&energy** programmi abil ja tulemused salvestatakse faili, mida saab seejärel kasutada radiaator – ja pörandakütte tehniliste parameetrite arvutamiseks.

AutoCAD programmi joonised DWG või DXF faili kujul saab importida **Instal-therm** programmi ja seejärel teha soojuskao arvutused **Instal-heat&energy** programmis. Seejärel saab joonised jälle AutoCAD programmi tagasi tõsta.

### Instal-san

Programm **Instal-san** kuuma – ja külma tarbevee süsteemide projekteerimiseks. Sisestades programmi andmed joonistab programm automaatselt torustike paigalduse skeemi. Seejärel saab teha hüdraulika ja muud süsteemielementide arvutused.

<b>Nimi</b>	300 EUR/ tk ilma KM
Instal – therm/heat&energy	175 EUR/ tk ilma KM
Instal-san	125 EUR/ tk ilma KM

# Märkused

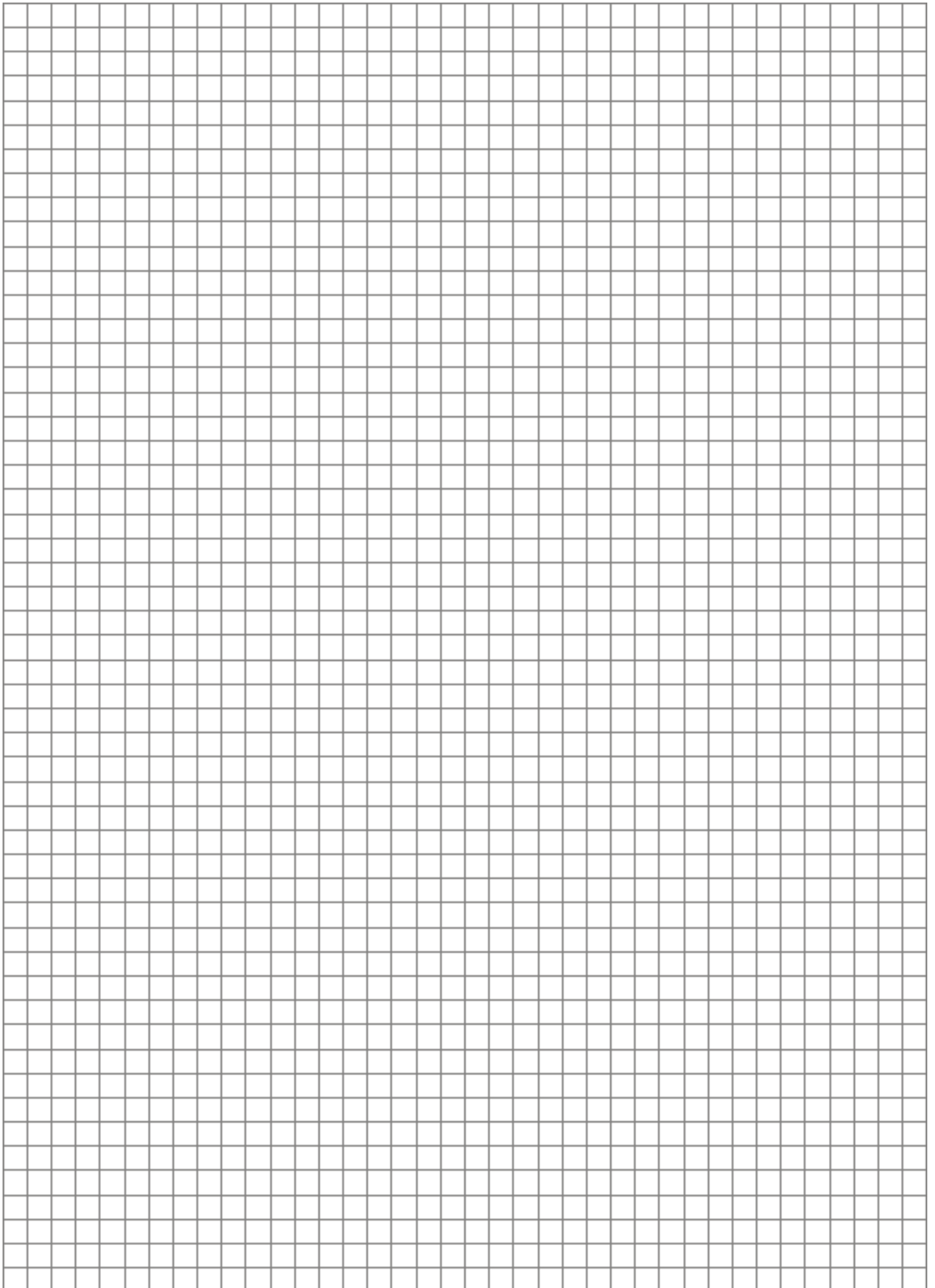





- **TECE**flex
- **TECE**logo
- **TECE**floor

